

VIDYA



part
A

Dr. Samir Kumar Mandal
M.A. (Drawing-Painting)
Ph.D. in Fine Arts
Kala-Shri Award for Art/Lit.

the game of
COLOURS

Knowledge of Colours

Primary Colours

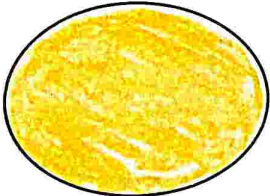

Yellow



Green

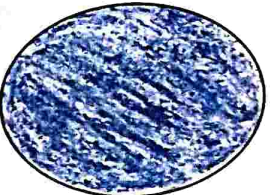

Blue



Red

Date _____

Secondary Colours

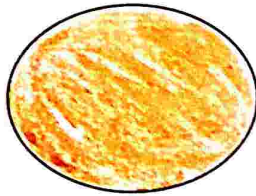

Orange



Parrot Green

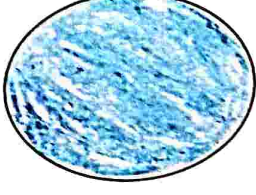

Sky Blue



Purple

Neutral Colours

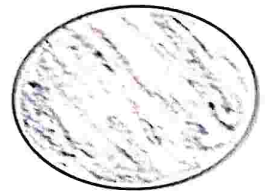

Grey

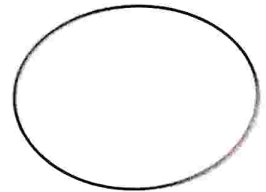

White



Black

Teacher's Signature _____

Know About Shapes

Now, let's learn some common shapes we see around us.
Colour the shapes with crayons in the same colour as in the border.

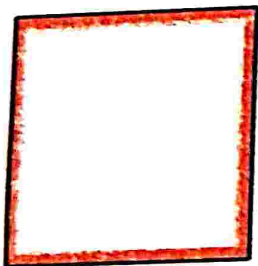

Square

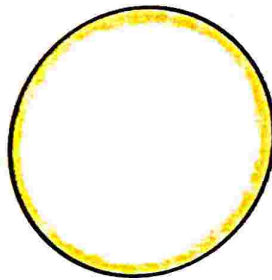

Circle

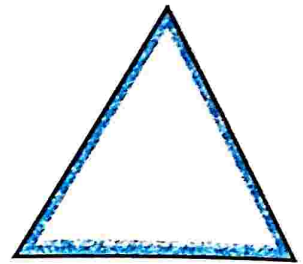

Triangle



Rectangle

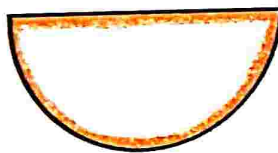

Semi-circle



Oval



Heart

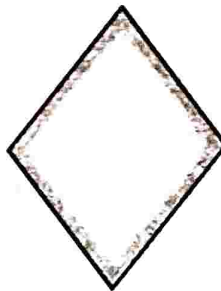

Diamond



Star

Teacher's Signature _____

Date _____

Tomato

Observe the coloured model drawing.
Join the dots by black sketch pen and
colour it.

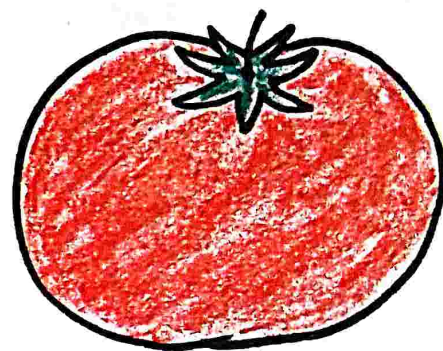
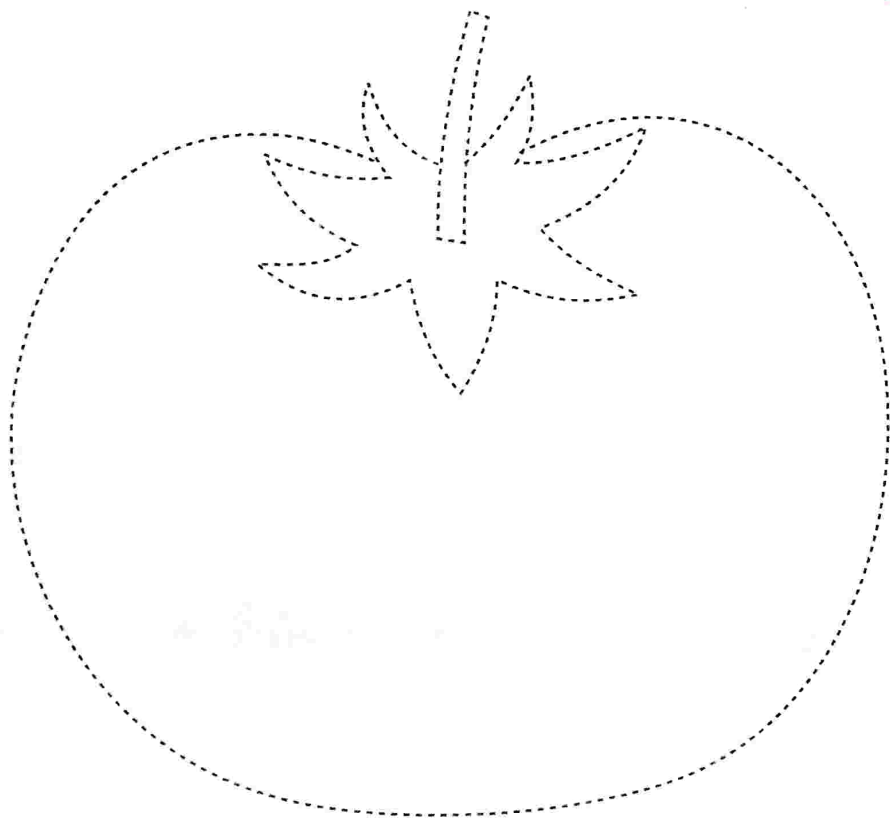

Date _____

Teacher's Signature _____

Flower

Observe the coloured model drawing.
Join the dots by black sketch pen and colour it.

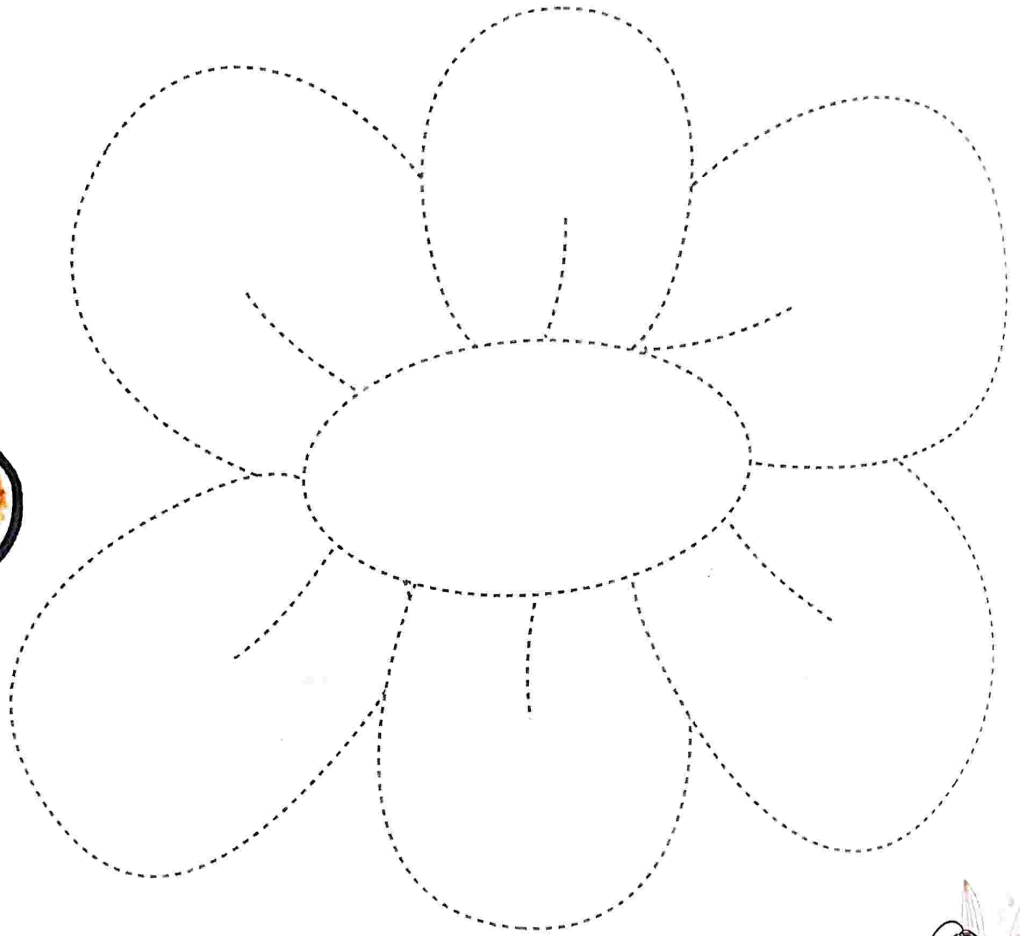
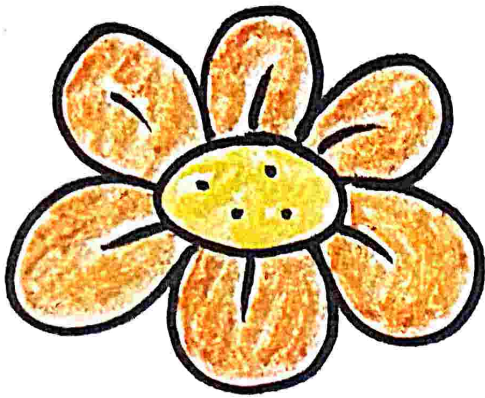

Date _____

Teacher's Signature _____

Brinjal

Observe the coloured model drawing.
Join the dots by black sketch pen and colour it.

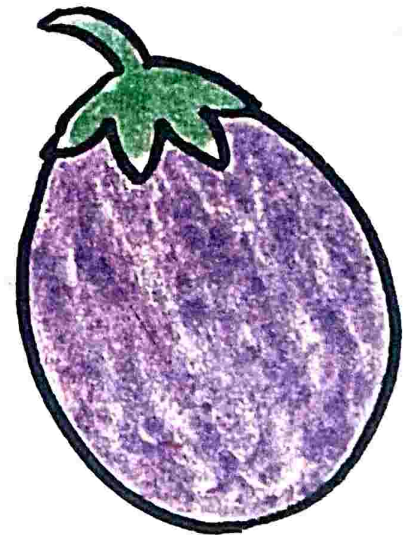
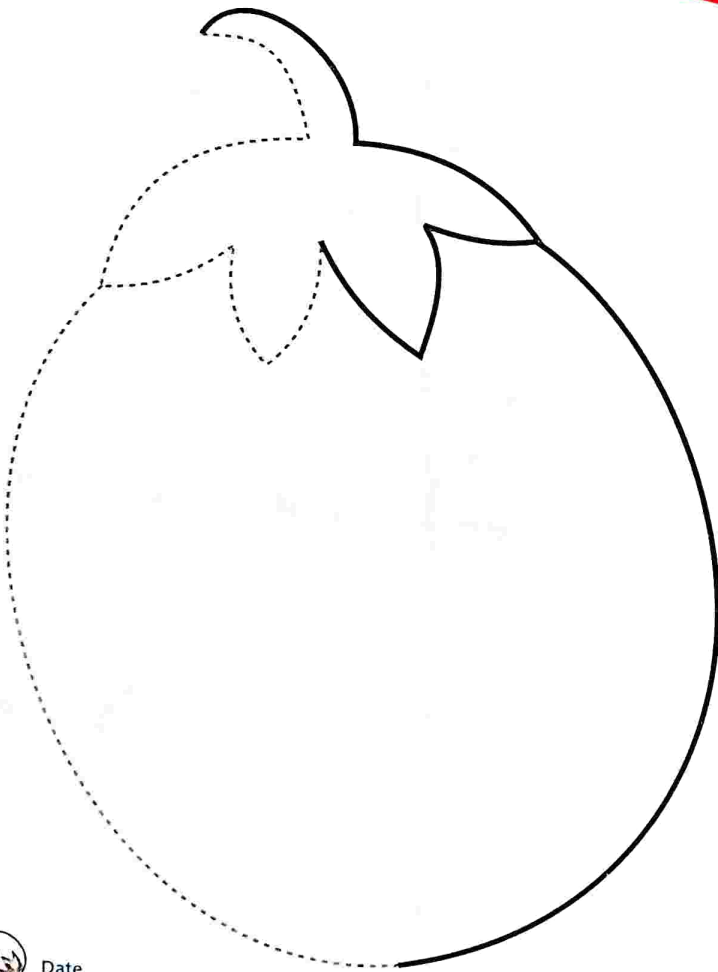

Date _____

Teacher's Signature _____



Leaves

Observe the coloured model drawing.
Join the dots by black sketch pen and colour it.

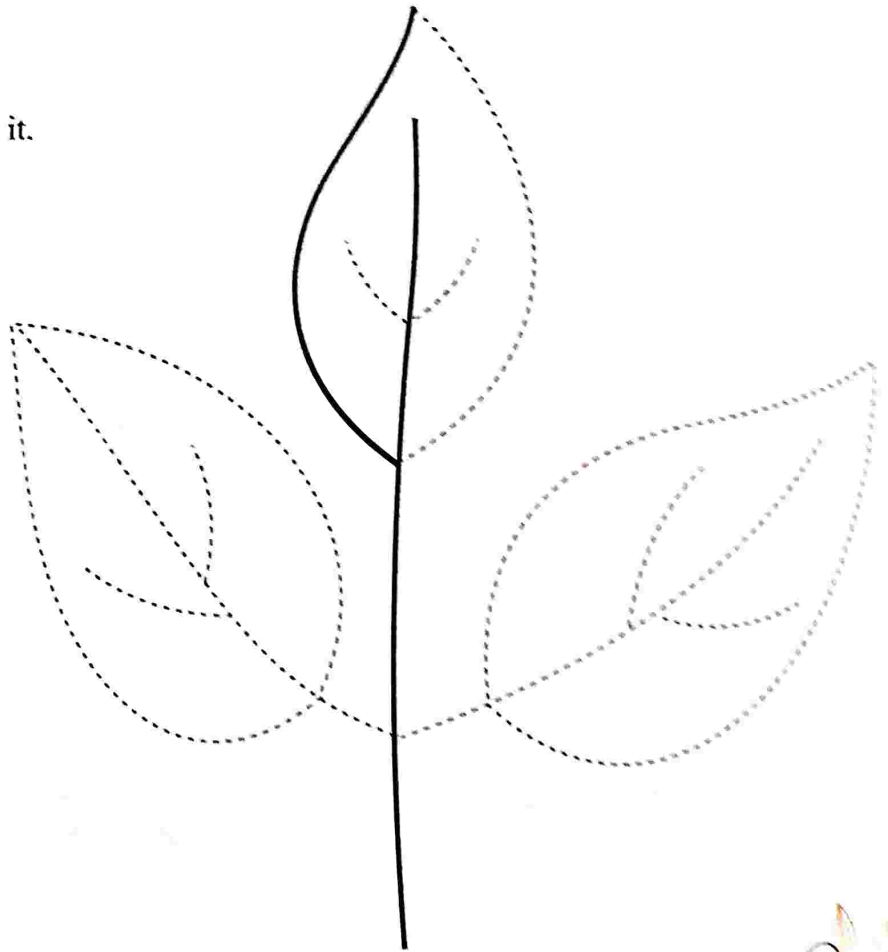
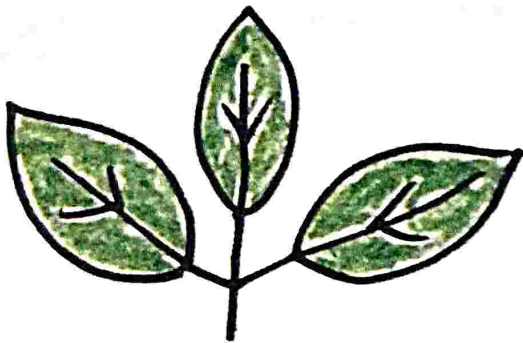

Date _____

Teacher's Signature _____

Flower

Observe the coloured model drawing.
Join the dots by black sketch pen and colour it.

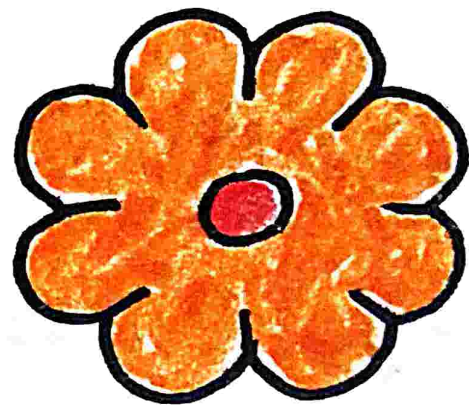
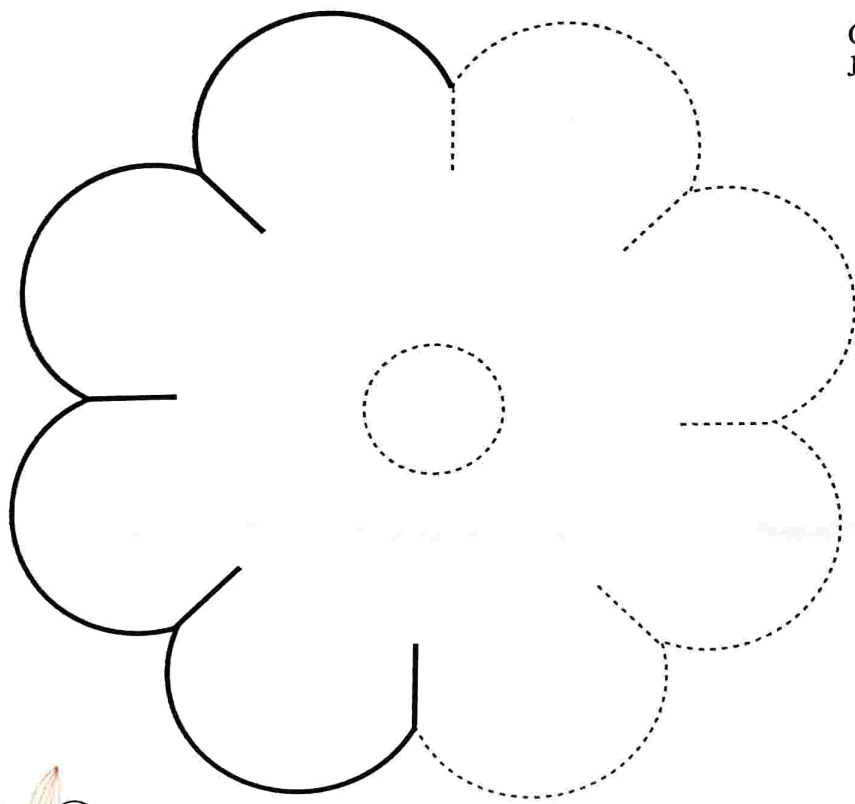

Date _____

Teacher's Signature _____

Plums

Observe the coloured model drawing.
Join the dots by black sketch pen and
colour it.

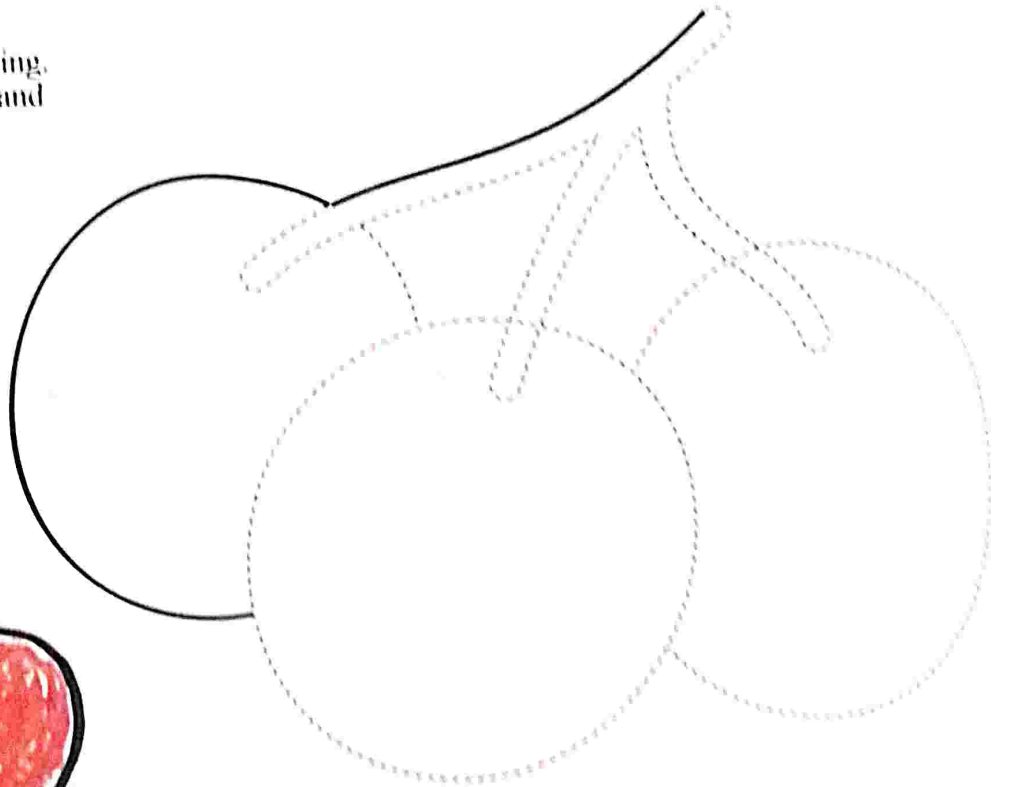
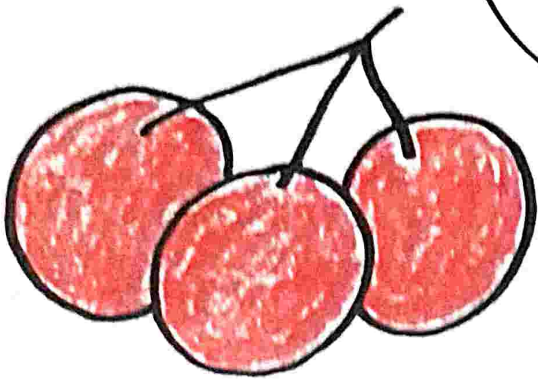

Date _____

Teacher's Signature _____

Apple

Observe the coloured model drawing.
Join the dots by black sketch pen and
colour it.

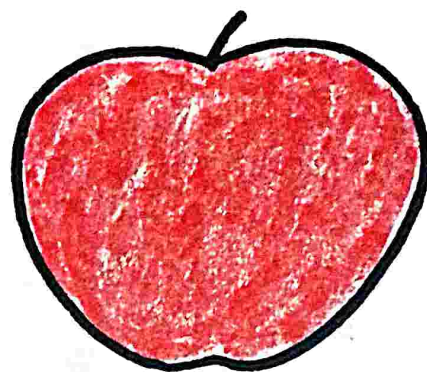
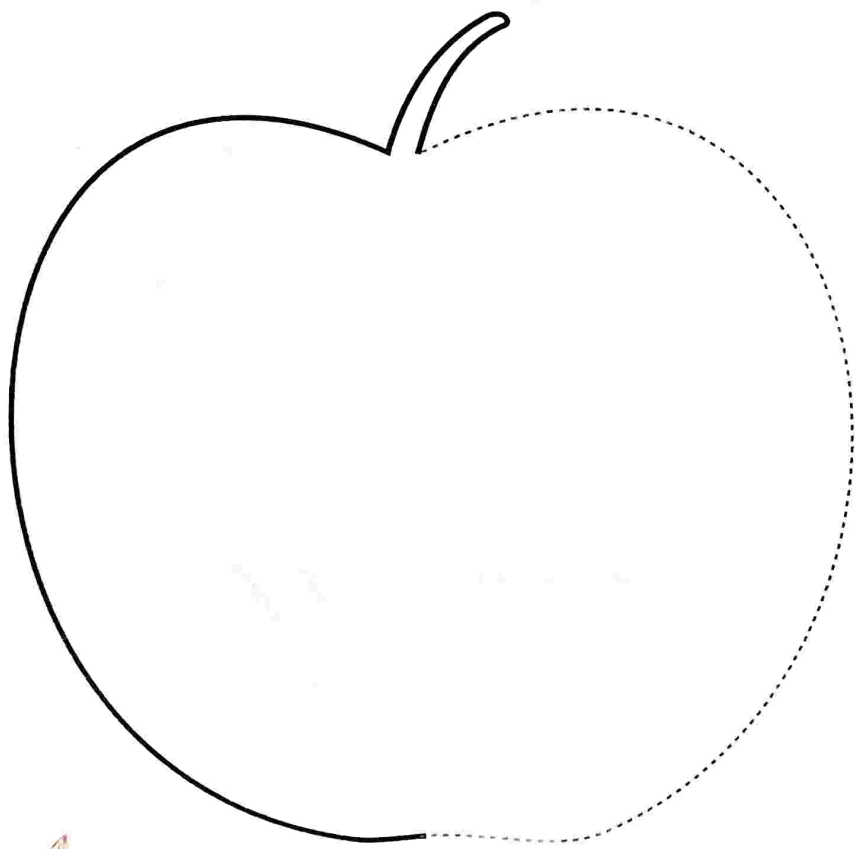

Date _____

Teacher's Signature _____

Mango

Observe the coloured model drawing.
Join the dots by black sketch pen and
colour it.

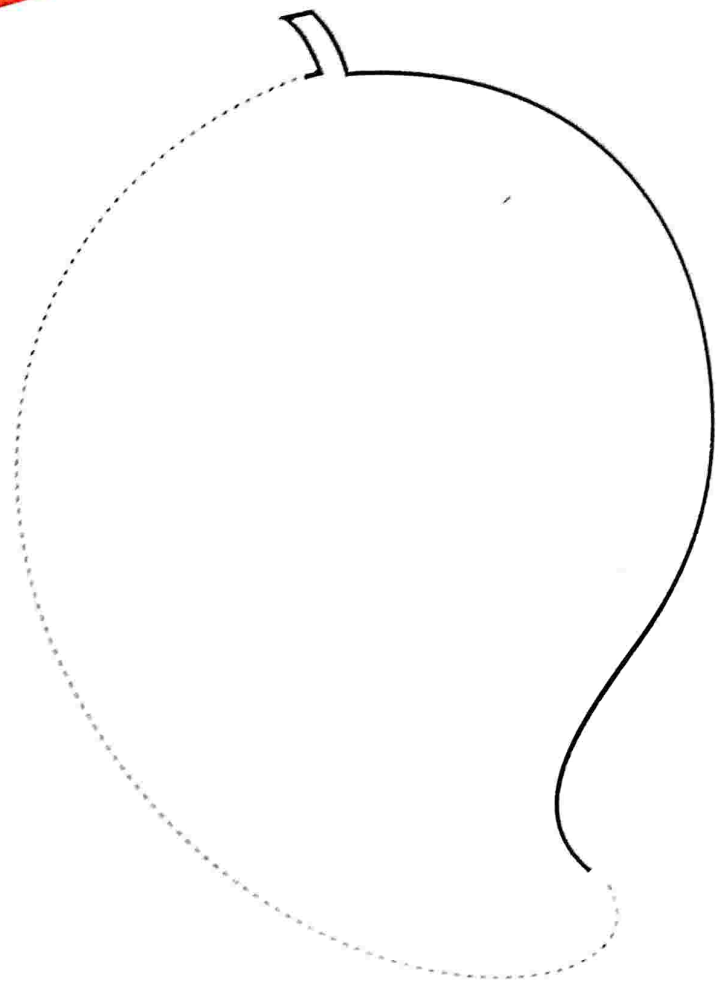
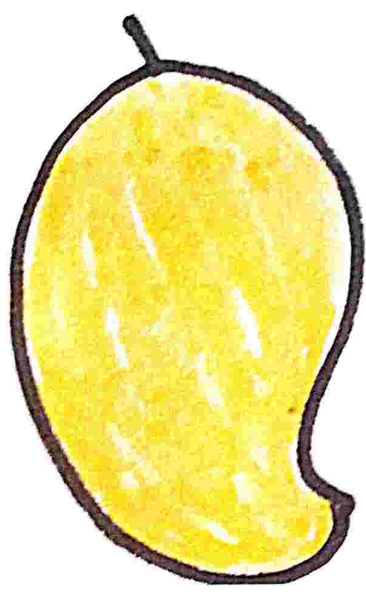

Date _____

Teacher's Signature _____

Betel

Observe the coloured model drawing.
Join the dots by black sketch pen and
colour it.

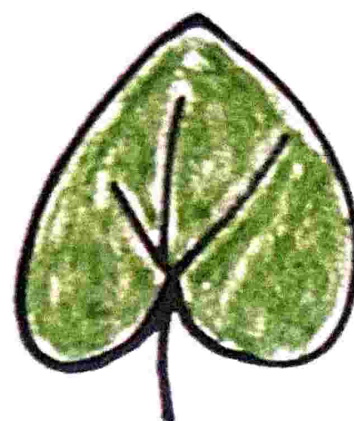
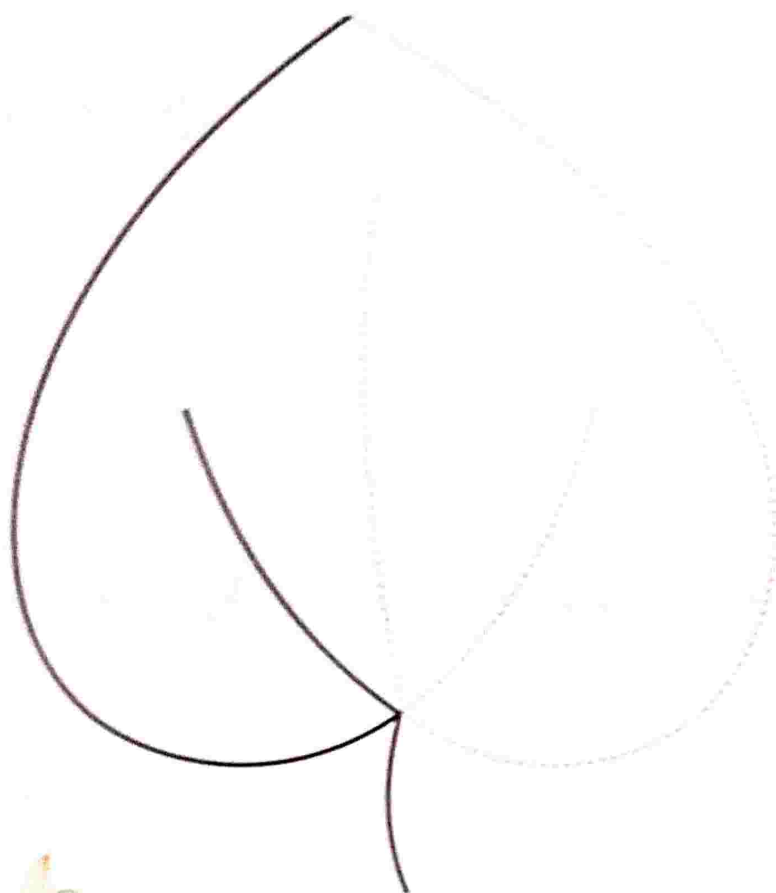

Date _____

Teacher's Signature _____



Bird

Observe the coloured model drawing.
Join the dots by black sketch pen and colour it.

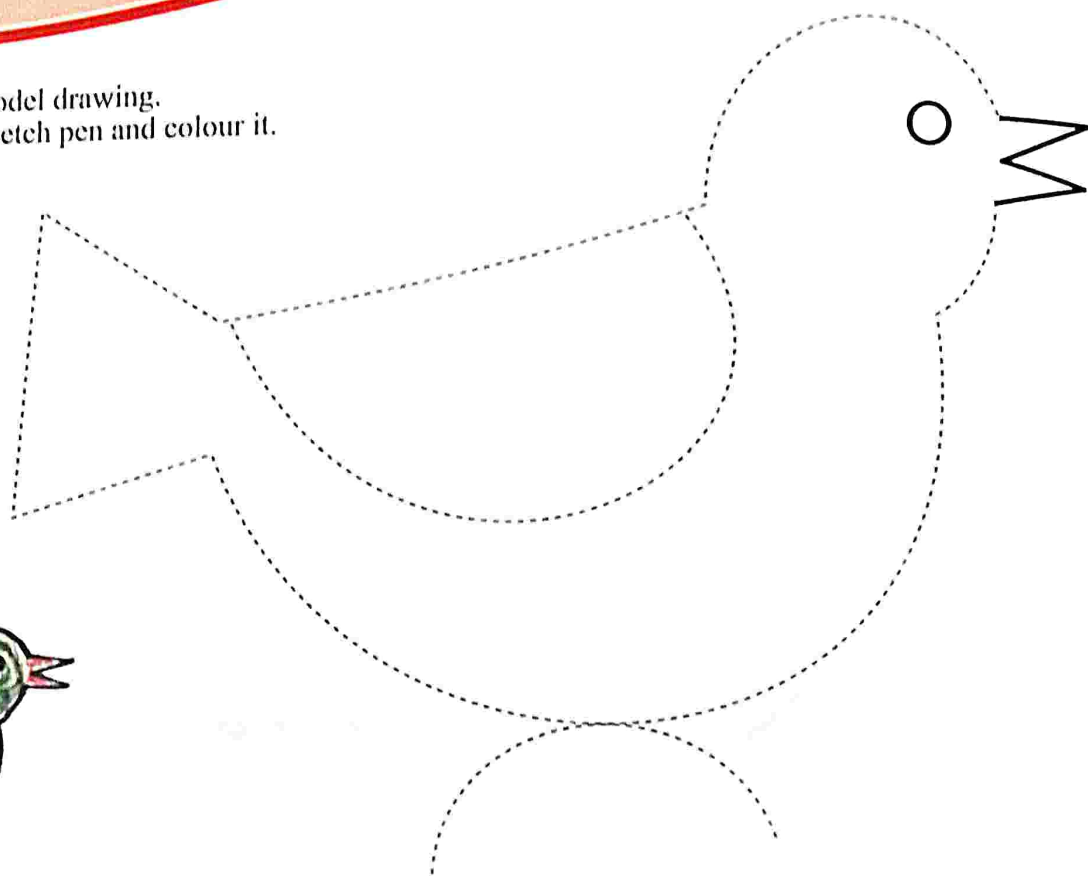
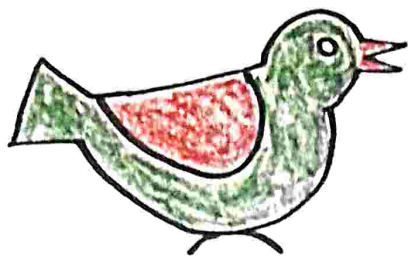

Date _____

Teacher's Signature _____



Rat



Observe the coloured model drawing.
Join the dots by black sketch pen and colour it.

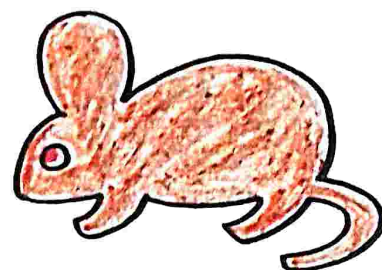
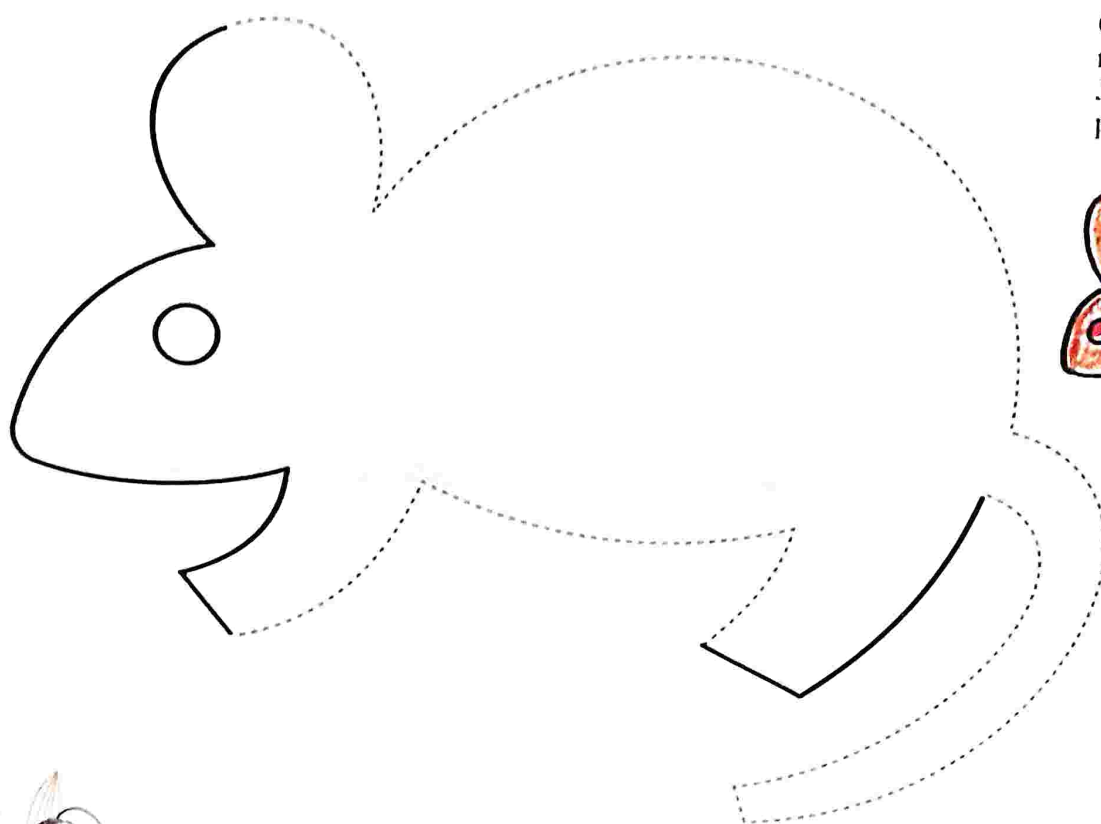

Date _____

Teacher's Signature _____



Toy

Observe the coloured model drawing.
Join the dots by black sketch pen and
colour it.

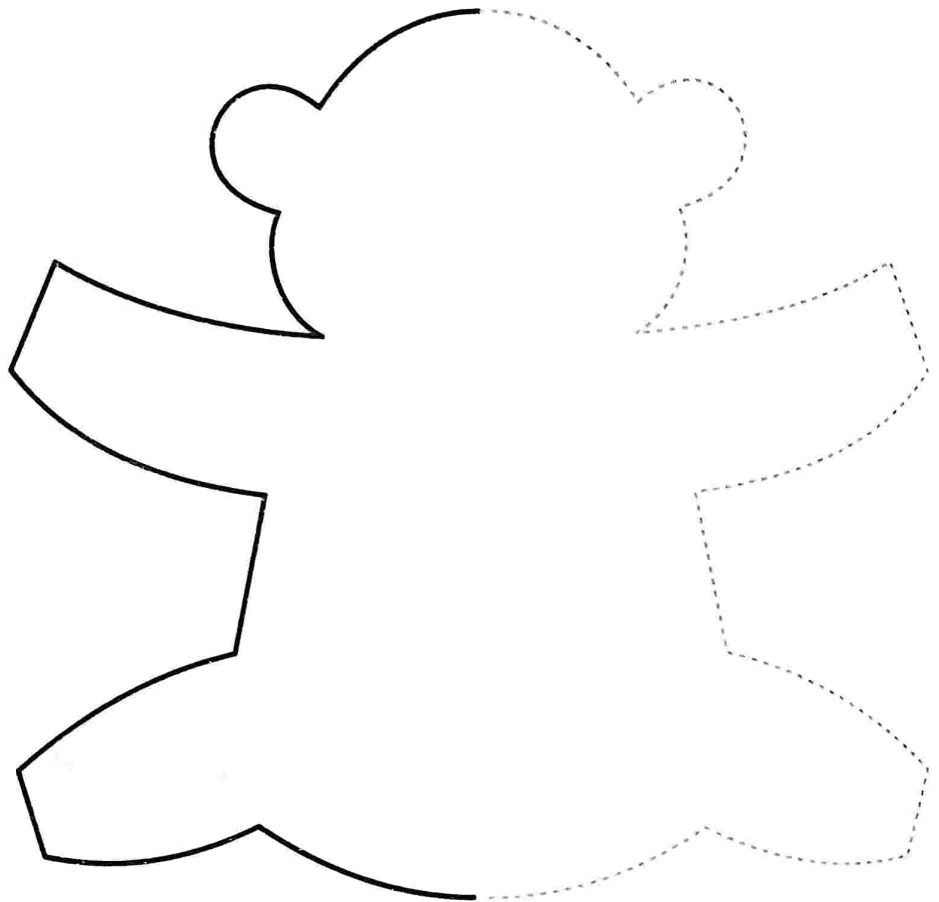

Date _____

Teacher's Signature _____



Fish



Observe the coloured model drawing. Join the dots by black sketch pen and colour it.

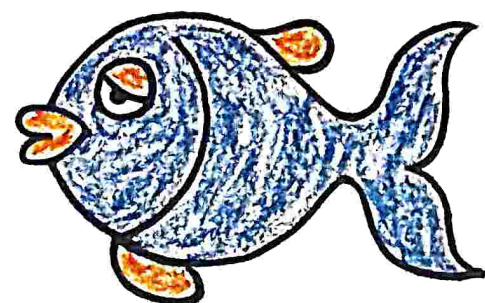
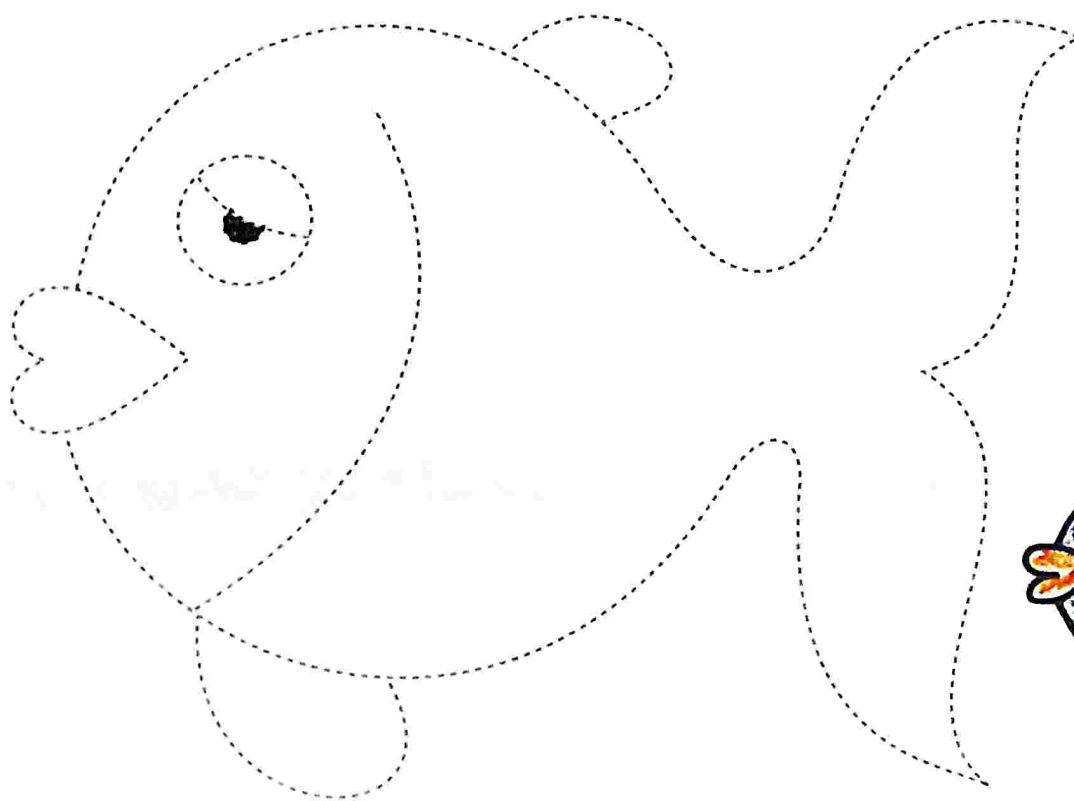

Date _____

Teacher's Signature _____

Snake

Observe the coloured model drawing.
Join the dots by black sketch pen and colour it.

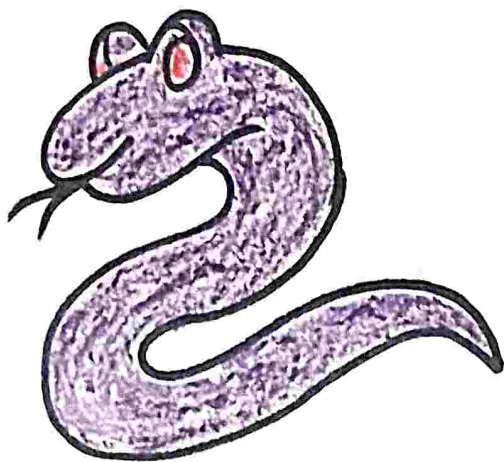

Date _____

Teacher's Signature _____



Ice cream

Observe the coloured model drawing.
Join the dots by black sketch pen and
colour it.

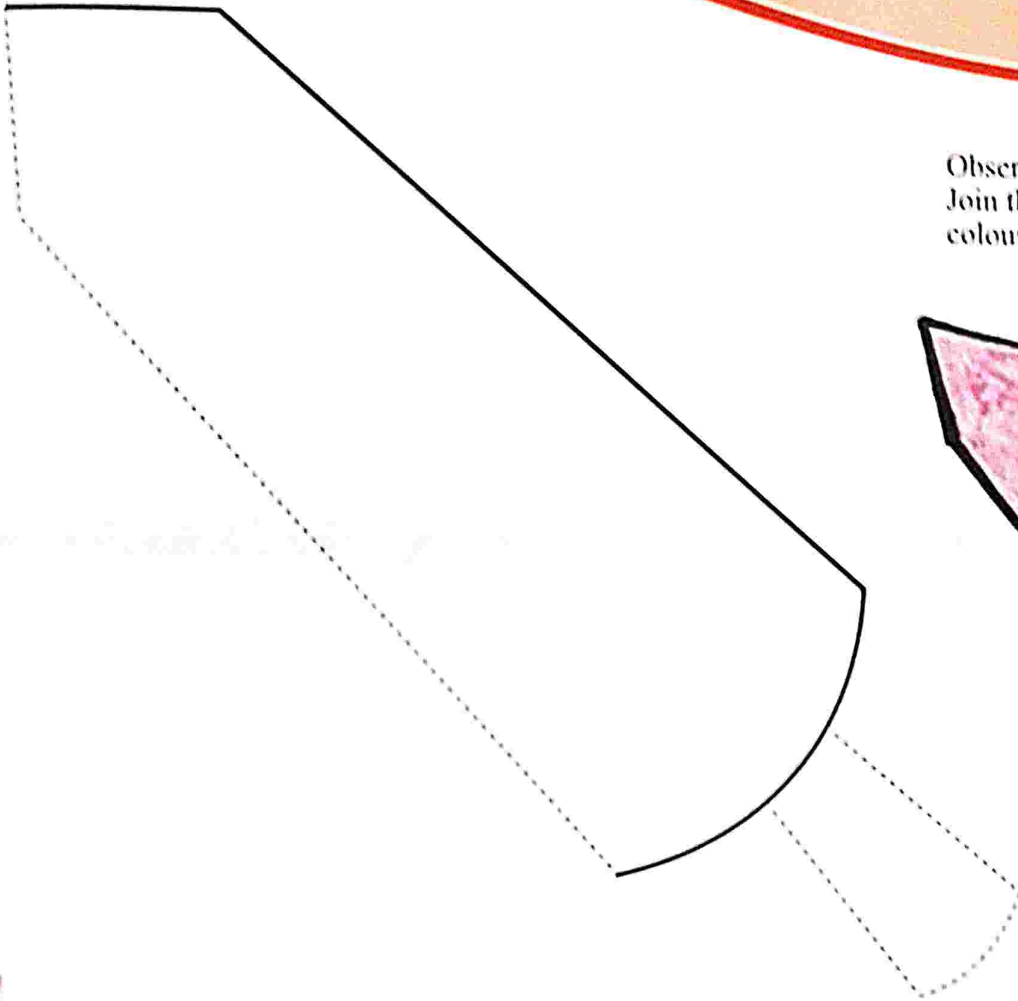

Date _____

Teacher's Signature _____

Moon

Observe the coloured model drawing.
Join the dots by black sketch pen
and colour it.

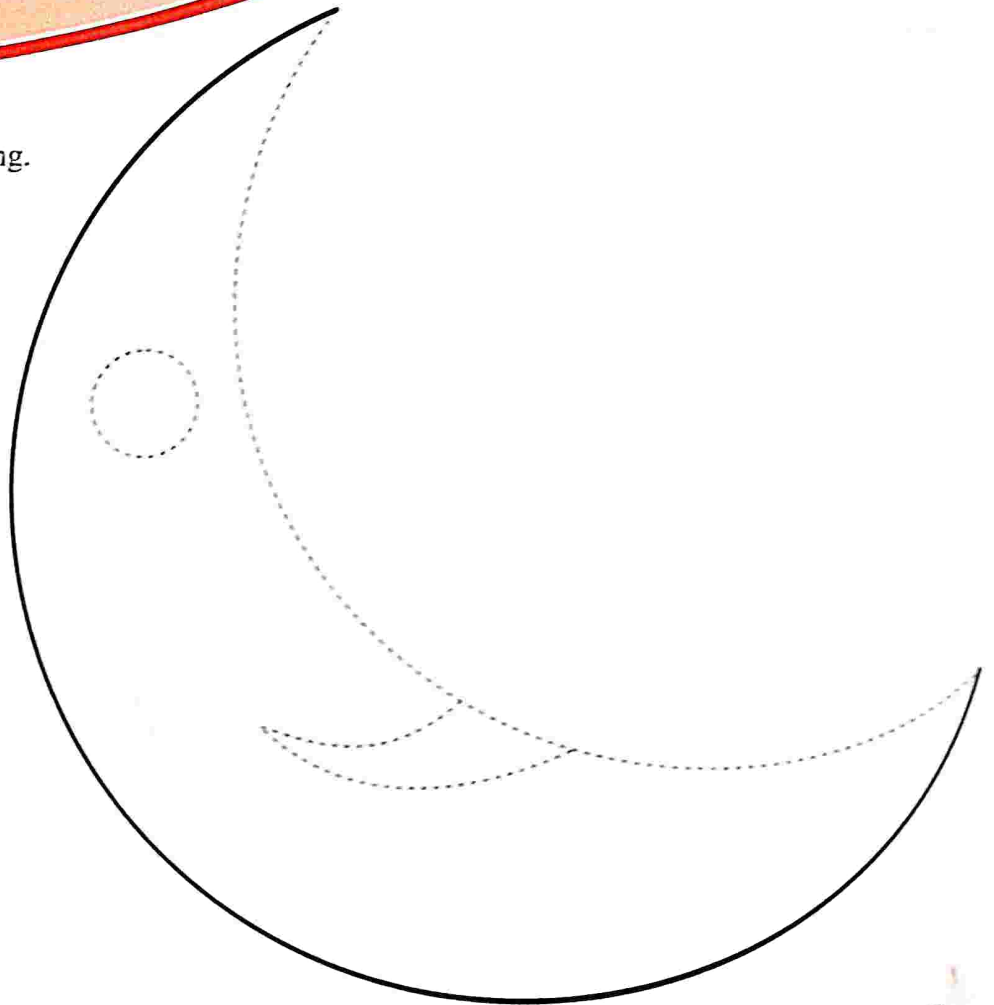
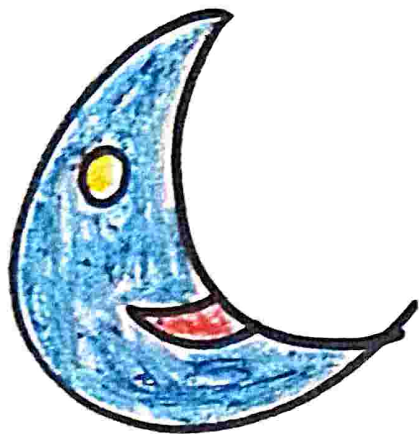

Date _____

Teacher's Signature _____

Diya



Observe the coloured model drawing.
Join the dots by black sketch pen and colour it.

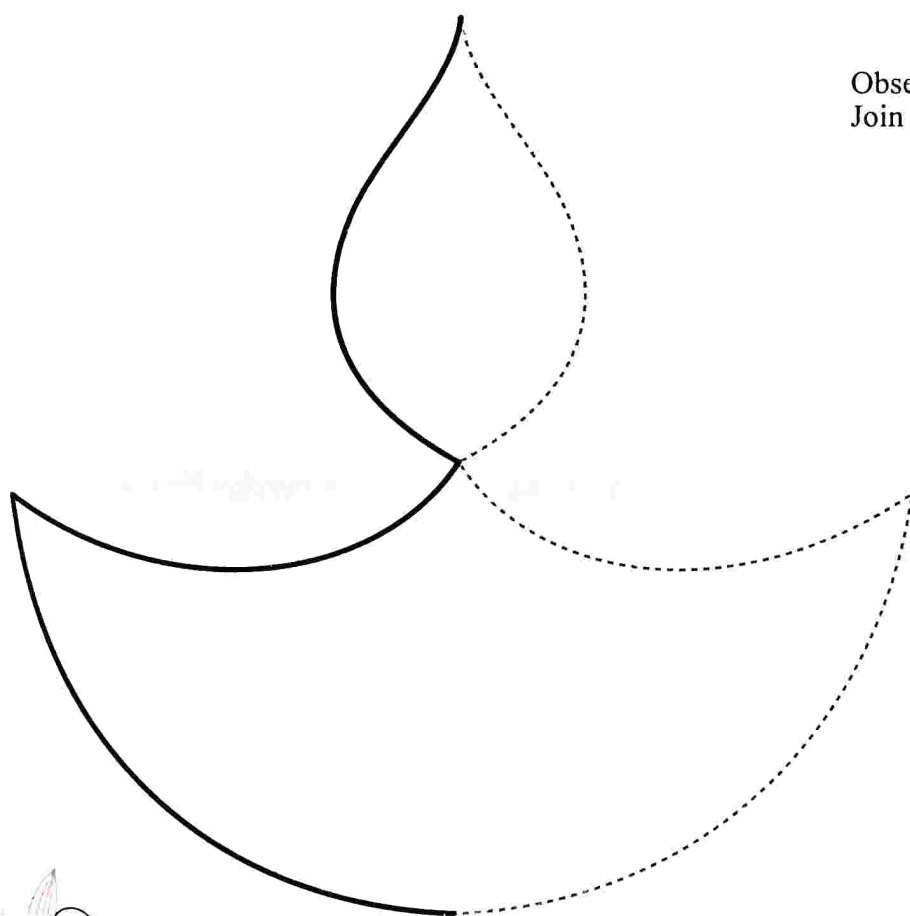

Date _____

Teacher's Signature _____



Cap

Observe the coloured model drawing.
Join the dots by black sketch pen and colour it.

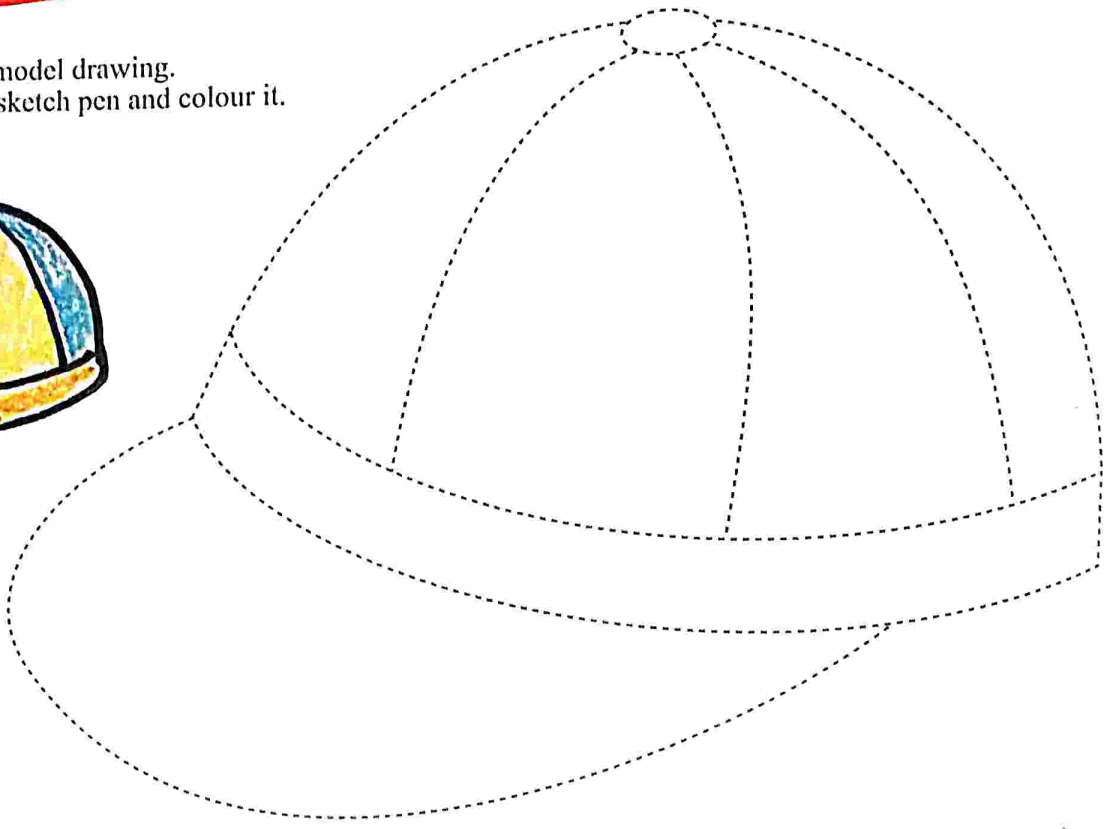
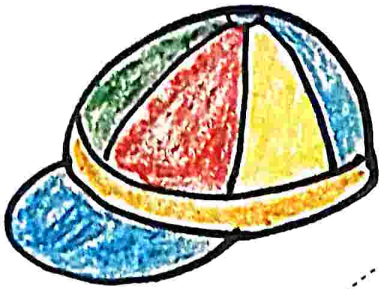

Date _____

Teacher's Signature _____



Flag

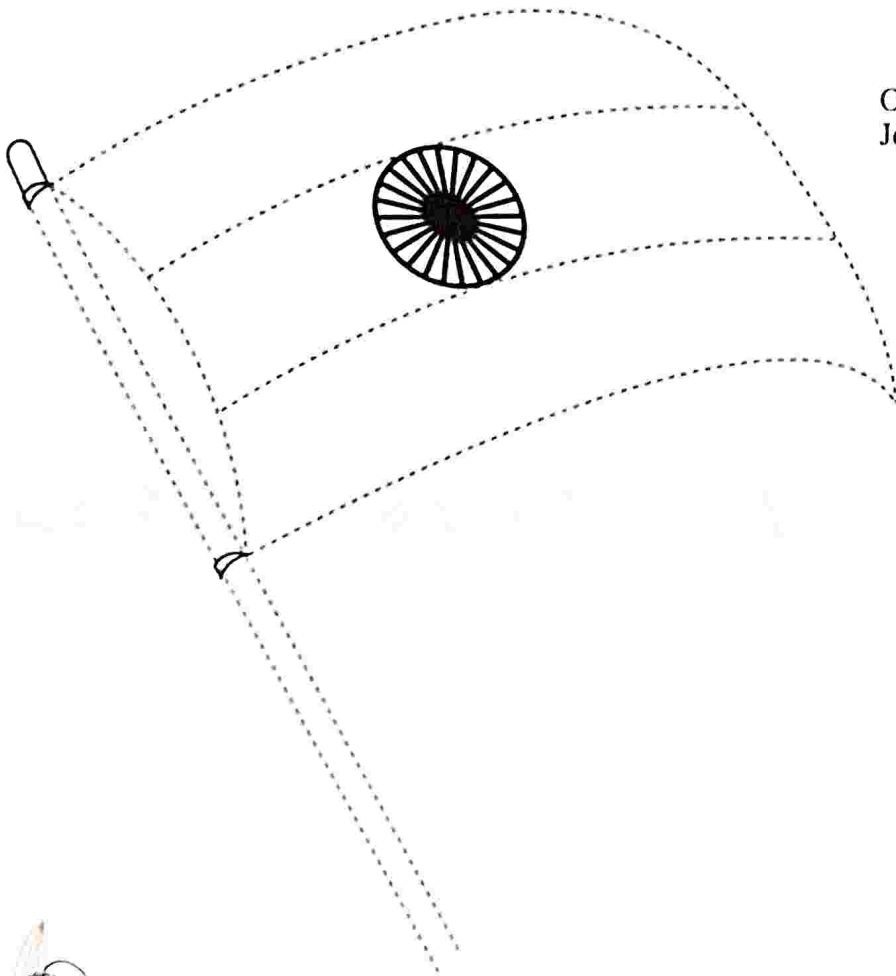

Observe the coloured model drawing.
Join the dots by black sketch pen and colour it.



Date _____

Teacher's Signature _____

Lock

Observe the coloured model drawing.
Join the dots by black sketch pen and colour it.

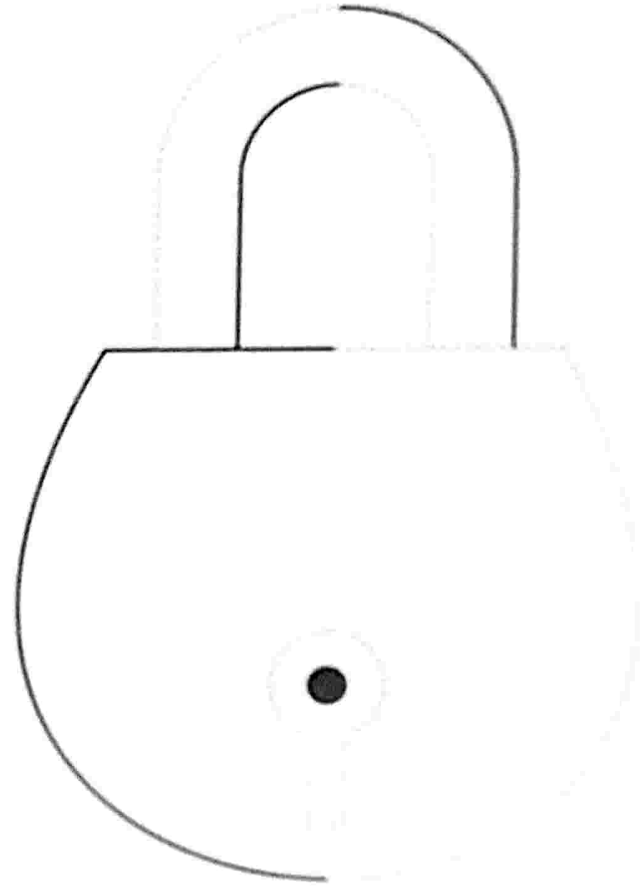

Date _____

Candle

Observe the coloured model drawing.
Join the dots by black sketch pen and colour it.

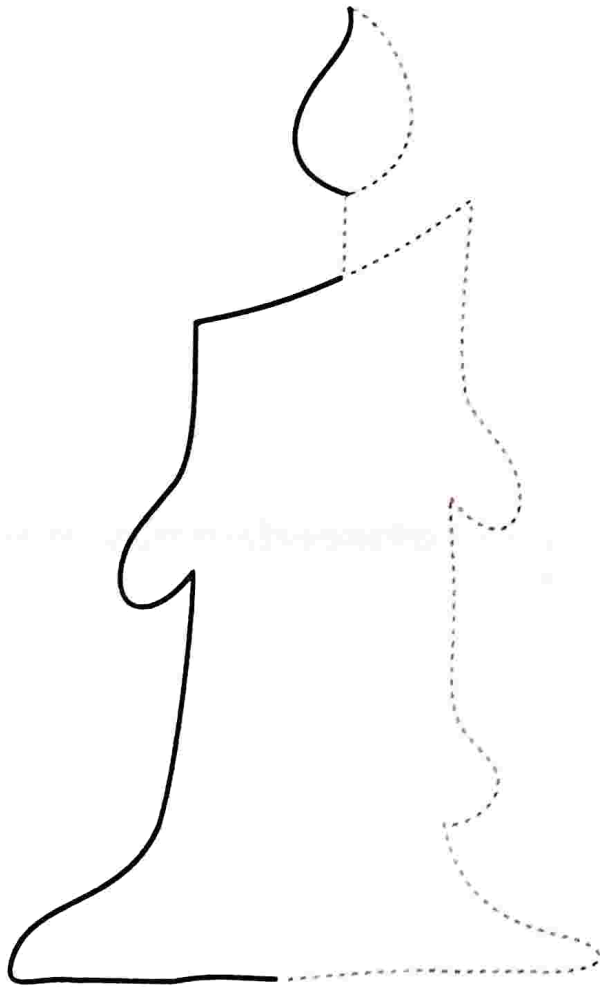

Date _____

Teacher's Signature _____

Boat

Observe the coloured model drawing.
Join the dots by black sketch pen and colour it.

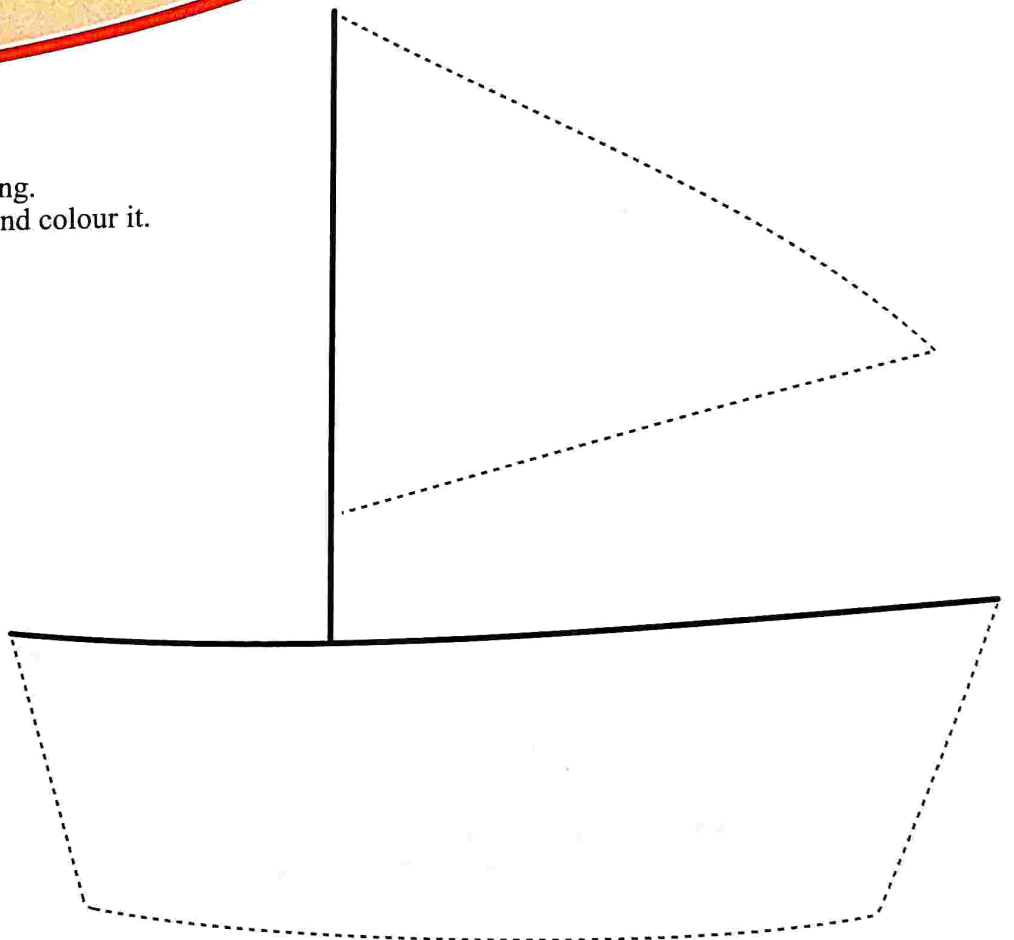
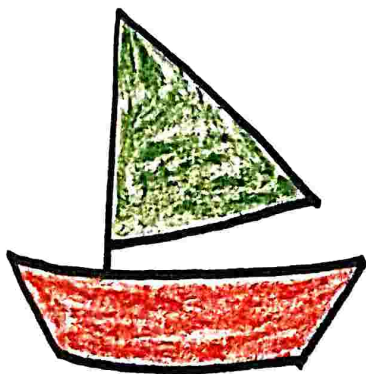

Date _____

Teacher's Signature _____





Observe the coloured model drawing.
Join the dots by black sketch pen and colour it.

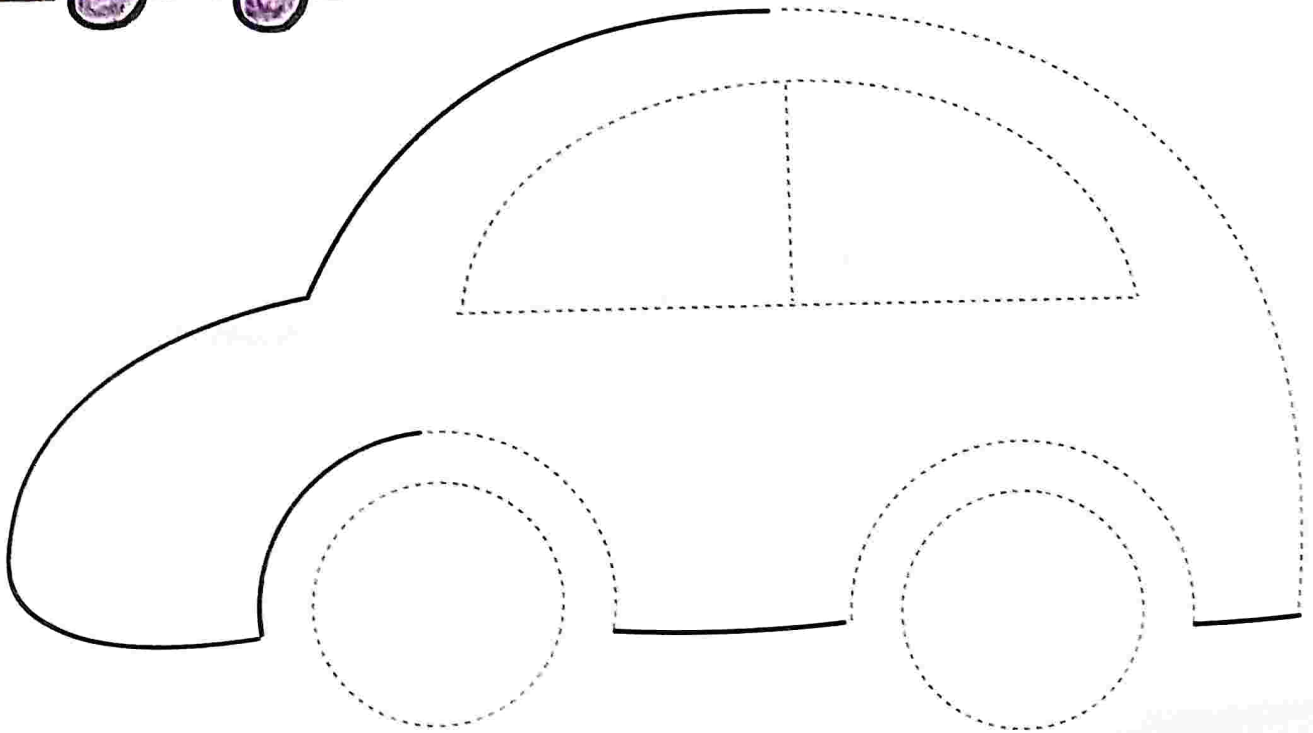

Date _____

Teacher's Signature _____

Kadahi

Observe the coloured model drawing.
Join the dots by black sketch pen and colour it.

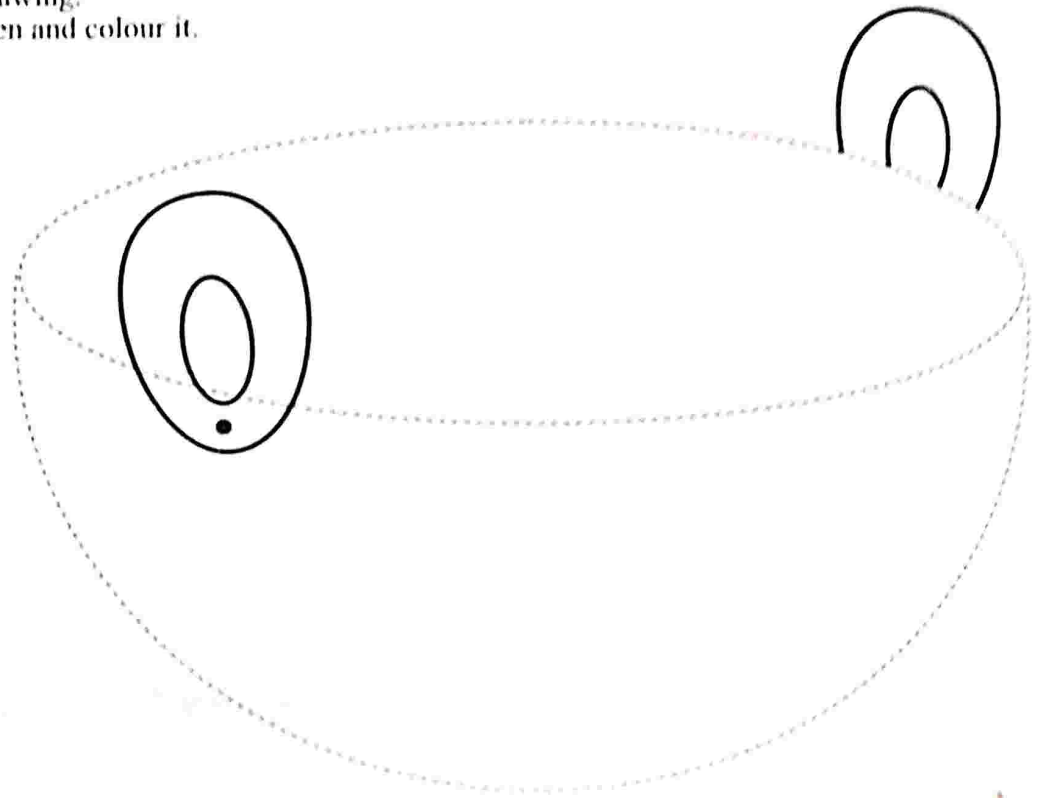
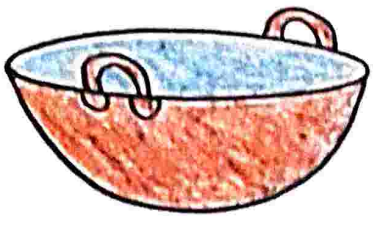

Date _____
26

Teacher's Signature _____

Cup



Observe the coloured model drawing.
Join the dots by black sketch pen and colour it.

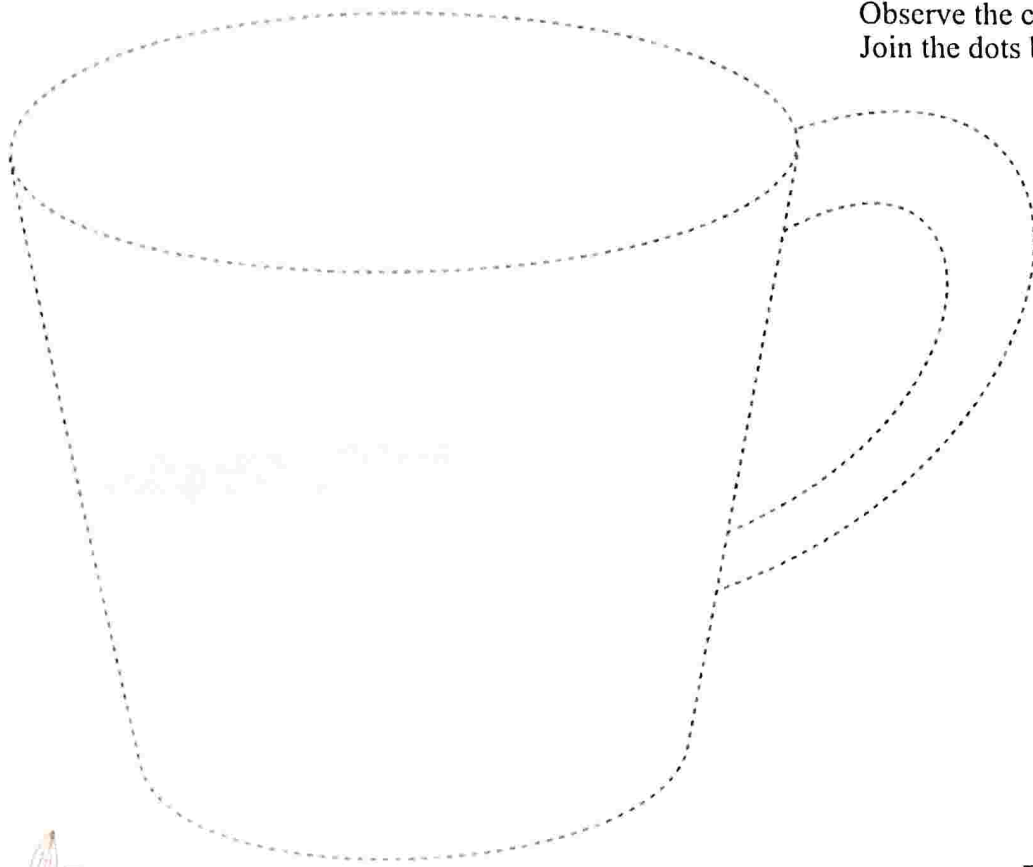

Date _____

Teacher's Signature _____

Model Drawing

Observe the coloured model drawing.
Join the dots by black sketch pen and
colour it.

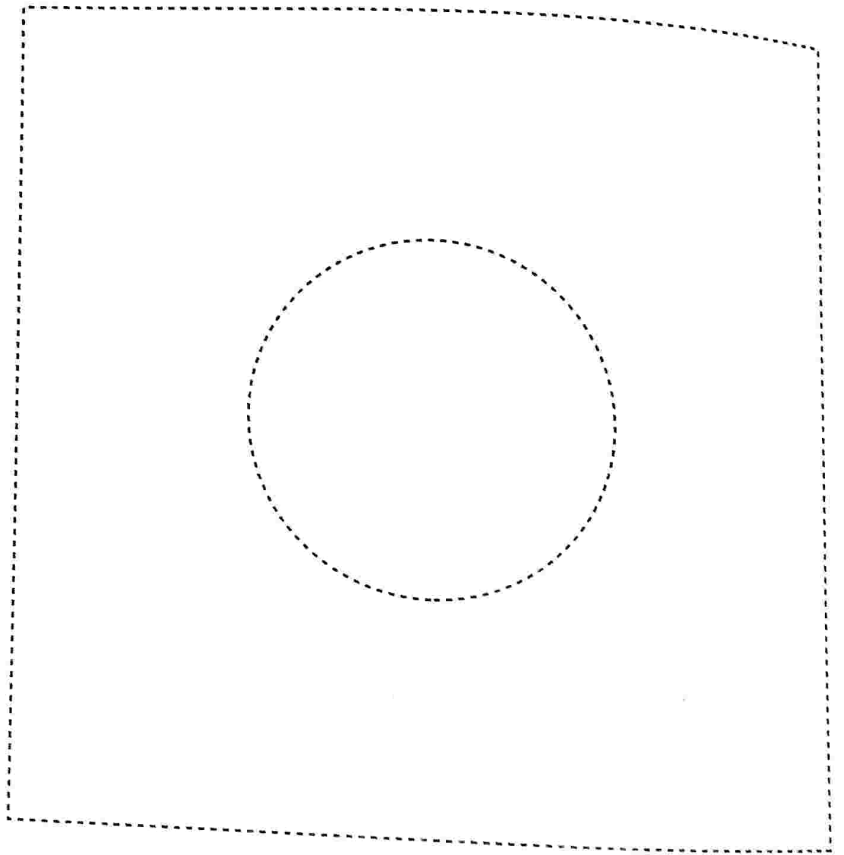
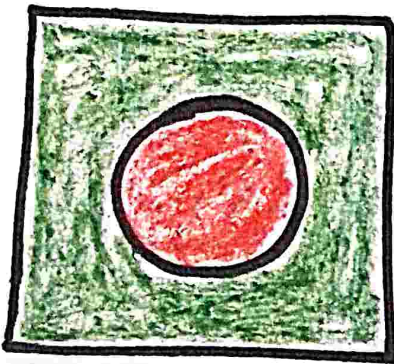

Date _____

28

Teacher's Signature _____

Model Drawing

Observe the coloured model drawing.
Join the dots by black sketch pen and colour it.

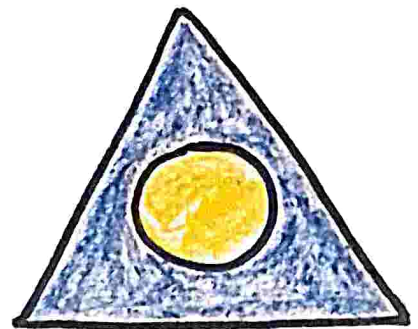
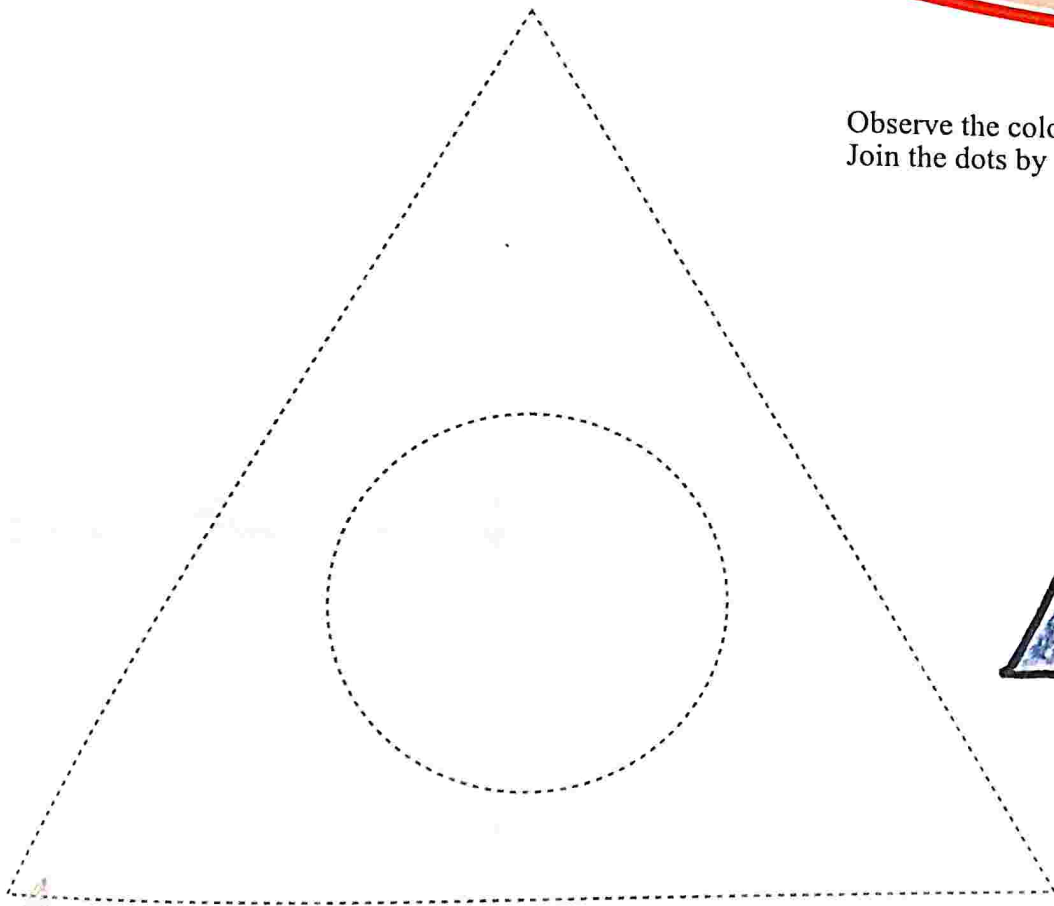

Date _____

Teacher's Signature _____

Model Drawing

Observe the coloured model drawing.
Join the dots by black sketch pen and colour it.

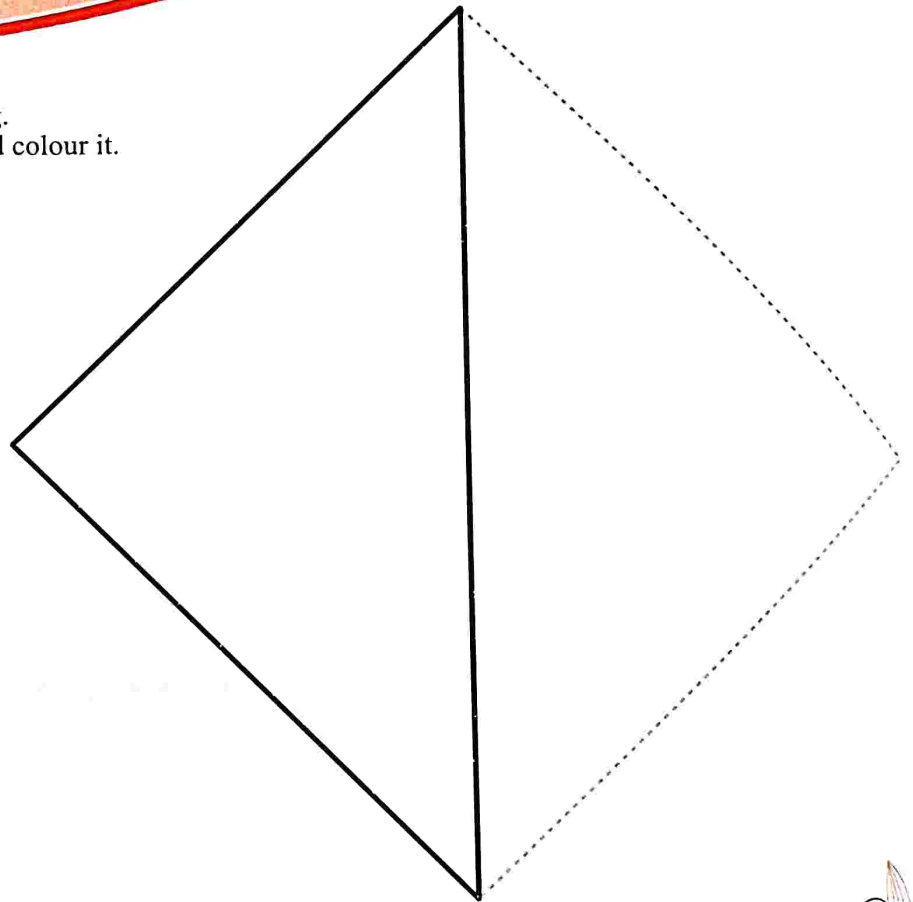
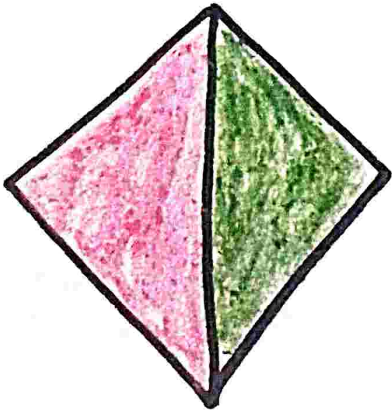

Date _____

30

Teacher's Signature _____

Kite

Observe the given picture.
Join the dots by black sketch pen and
colour it.

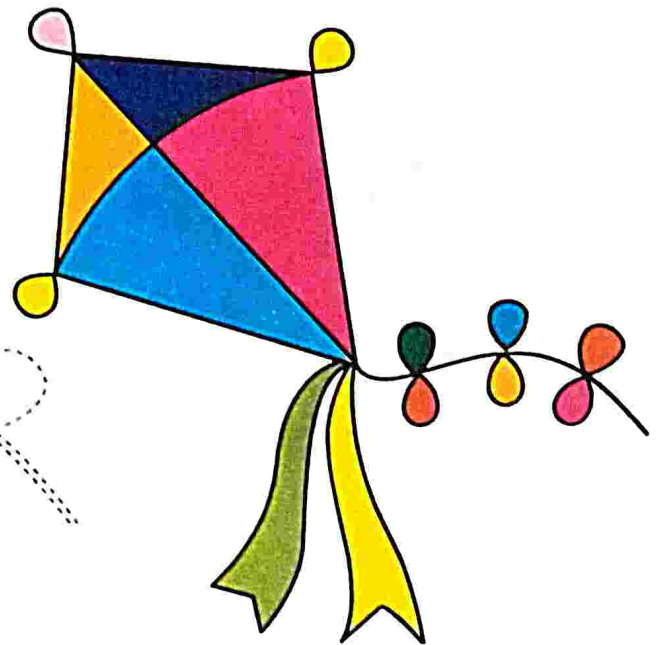
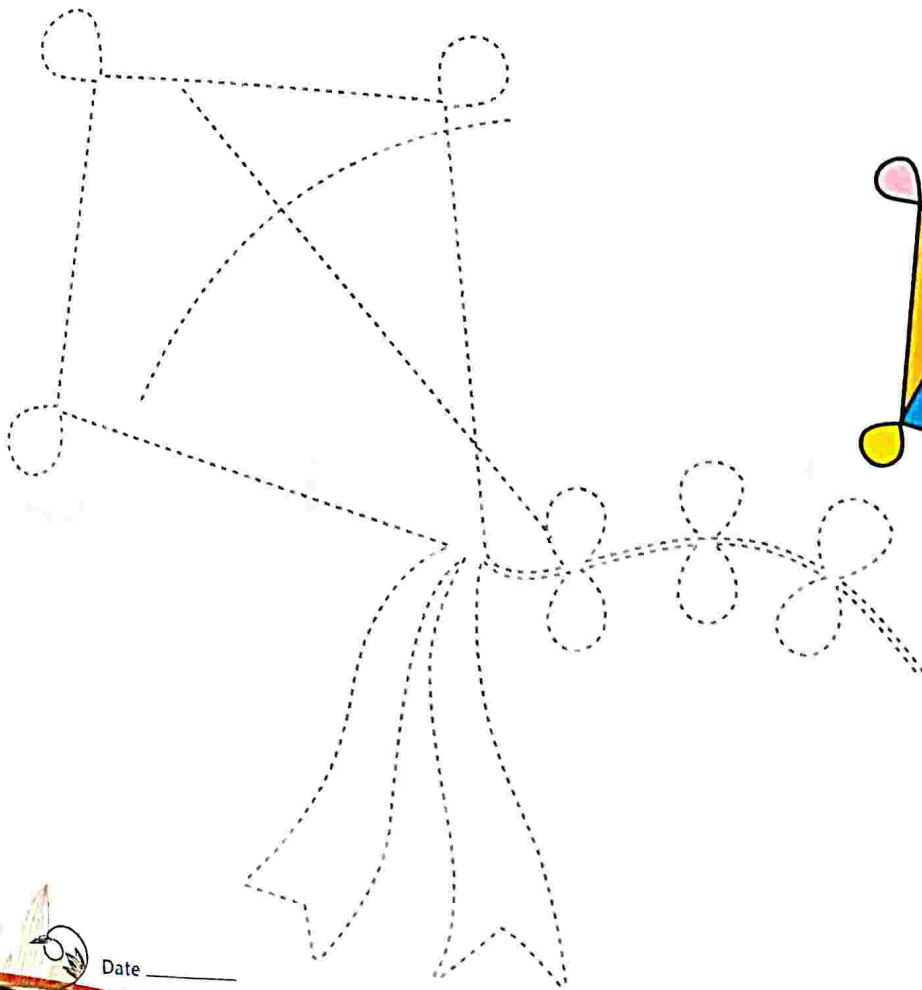

Date _____

Teacher's Signature _____

Pear

Observe the given picture.
Colour the picture with crayons in the same
colour as in the border.

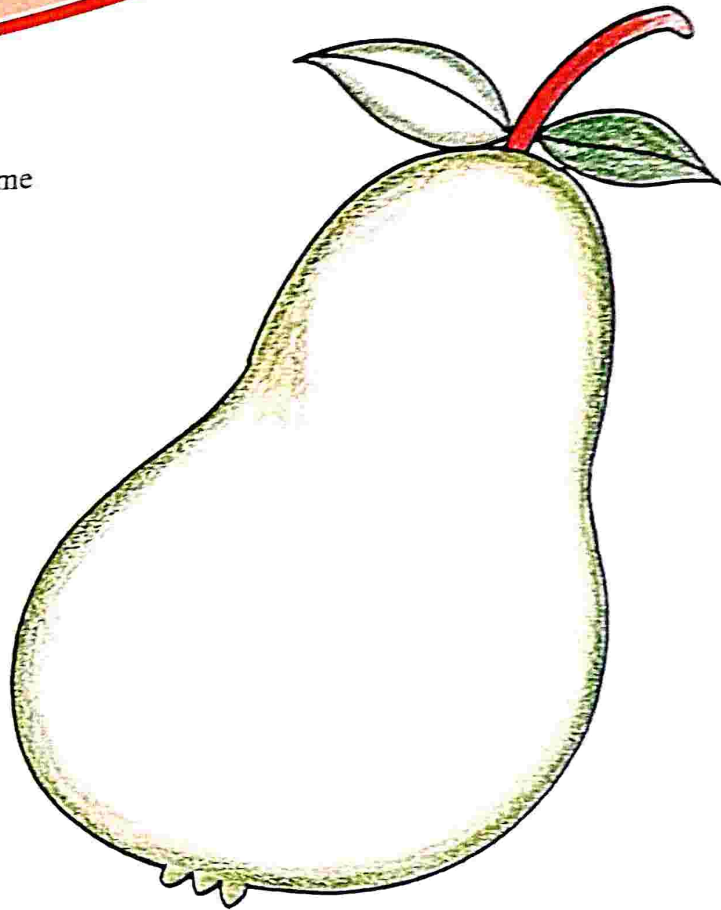
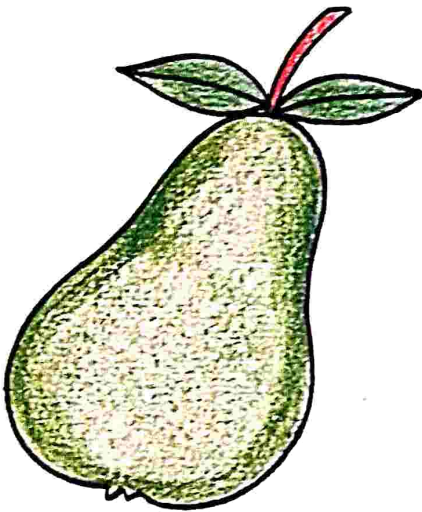

Date _____

Teacher's Signature _____

Ball



Observe the coloured model drawing.
Join the dots by black sketch pen and colour it.

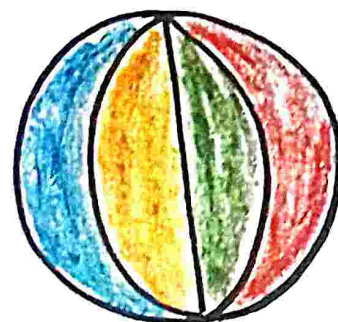
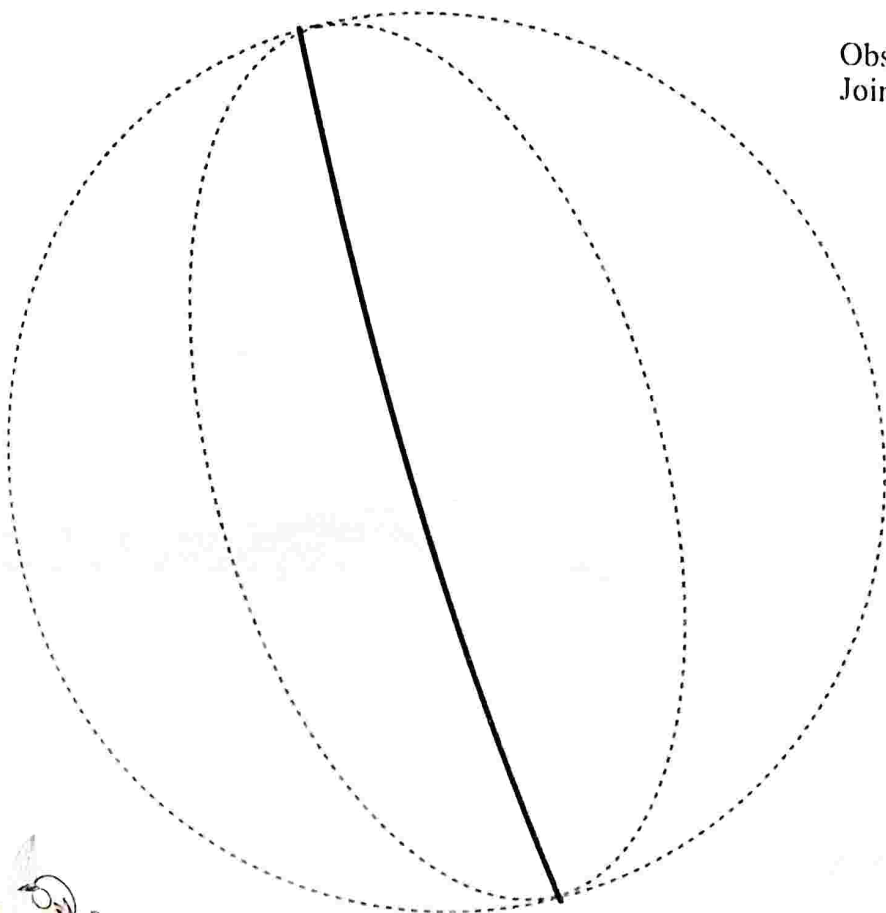

Date _____

Teacher's Signature _____



Model Drawing

Observe the coloured model drawing.
Join the dots by black sketch pen and colour it.

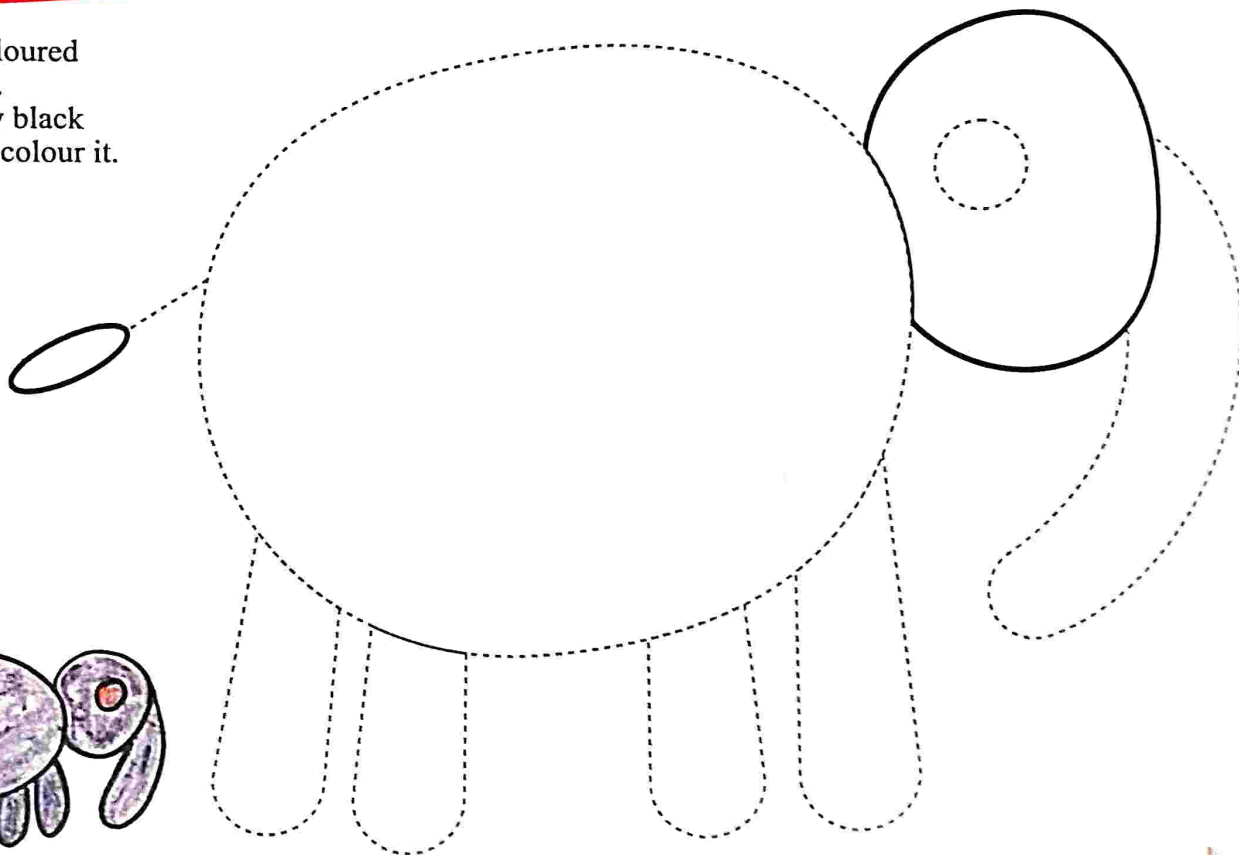
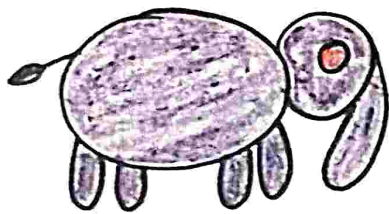

Date _____

Teacher's Signature _____



Hat

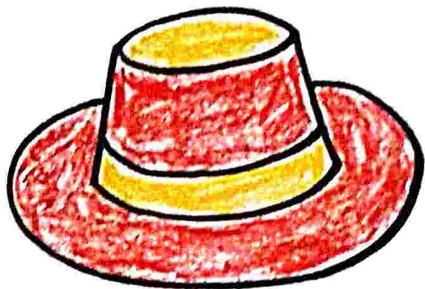

Observe the coloured model drawing.
Join the dots by black sketch pen and colour it.

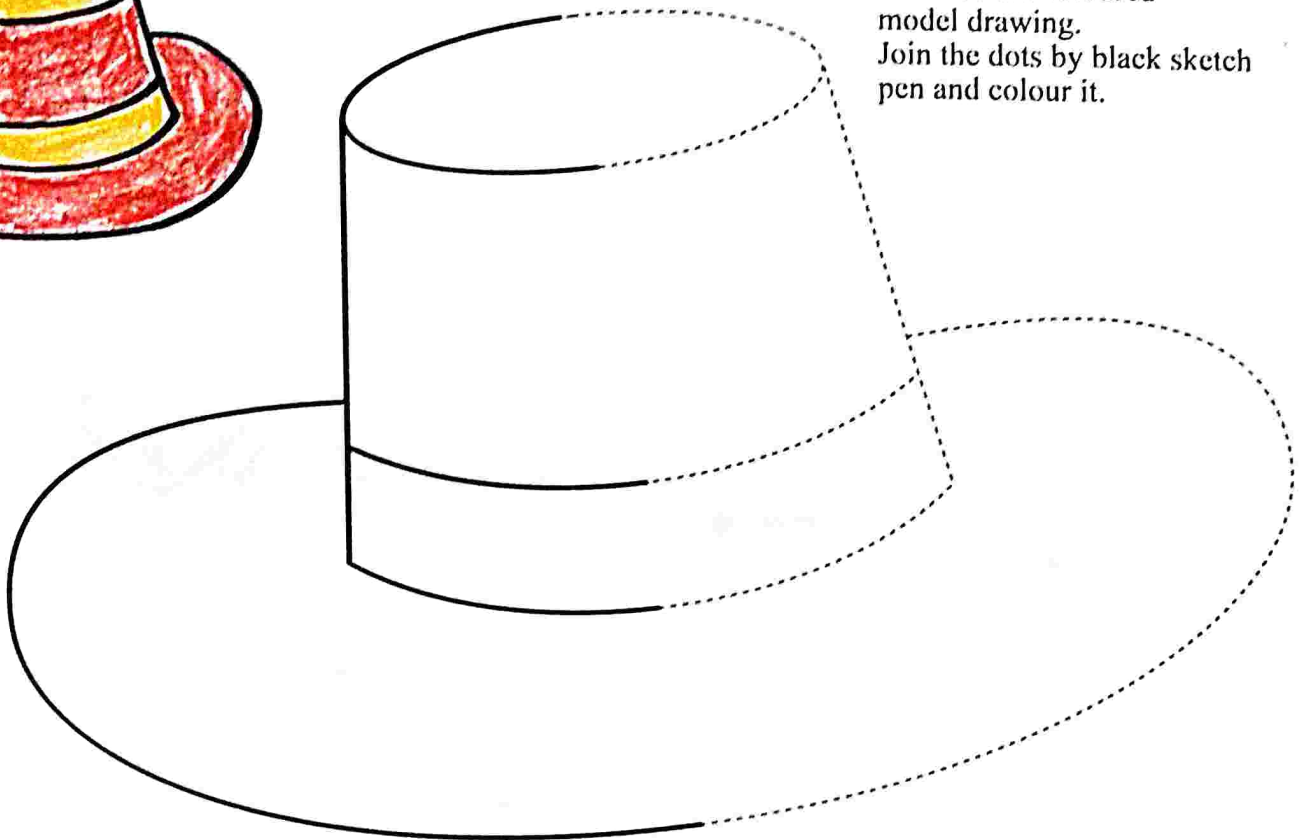

Date _____

Teacher's Signature _____

Ice Cream

Observe the coloured model drawing.
Join the dots by black sketch pen and colour it.

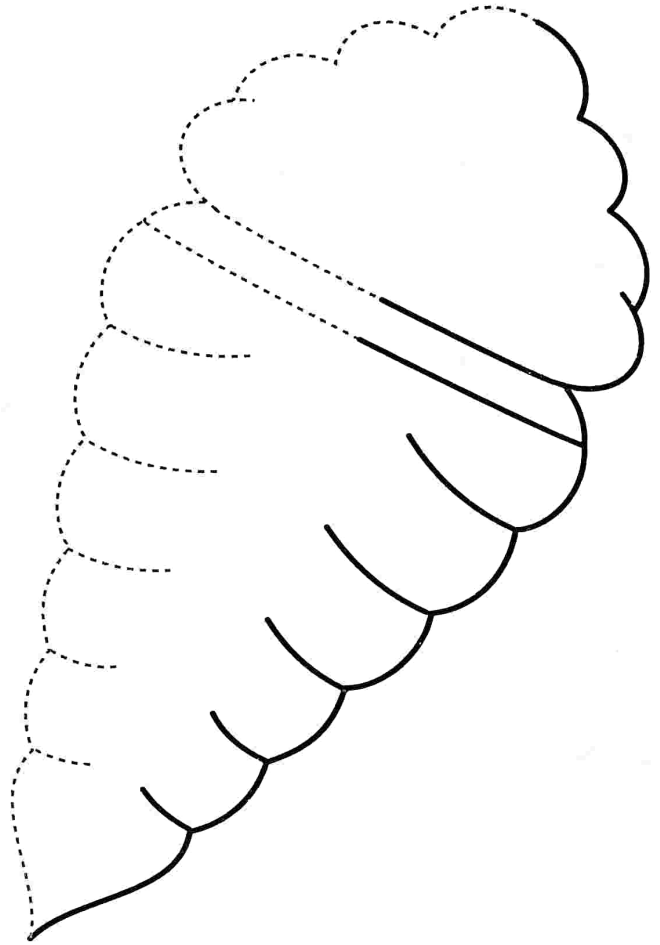
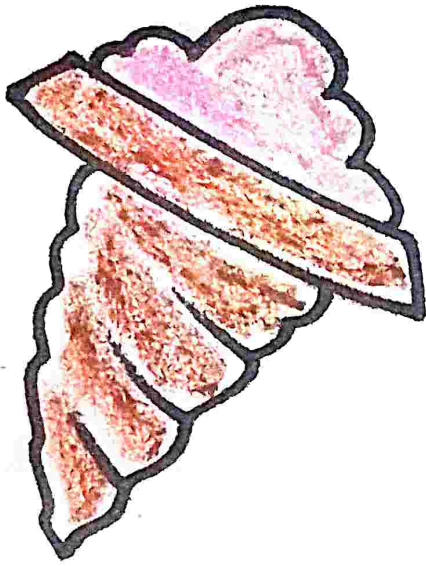

Date _____

36

Teacher's Signature _____



Observe the coloured model drawing.
Join the dots by black sketch pen and colour it.

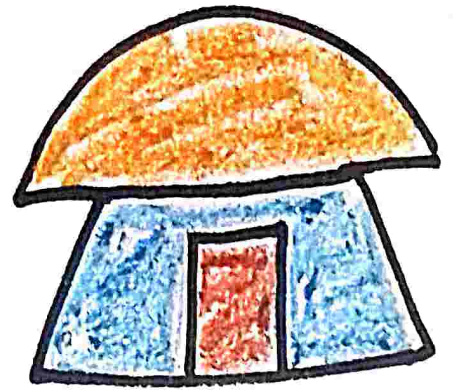
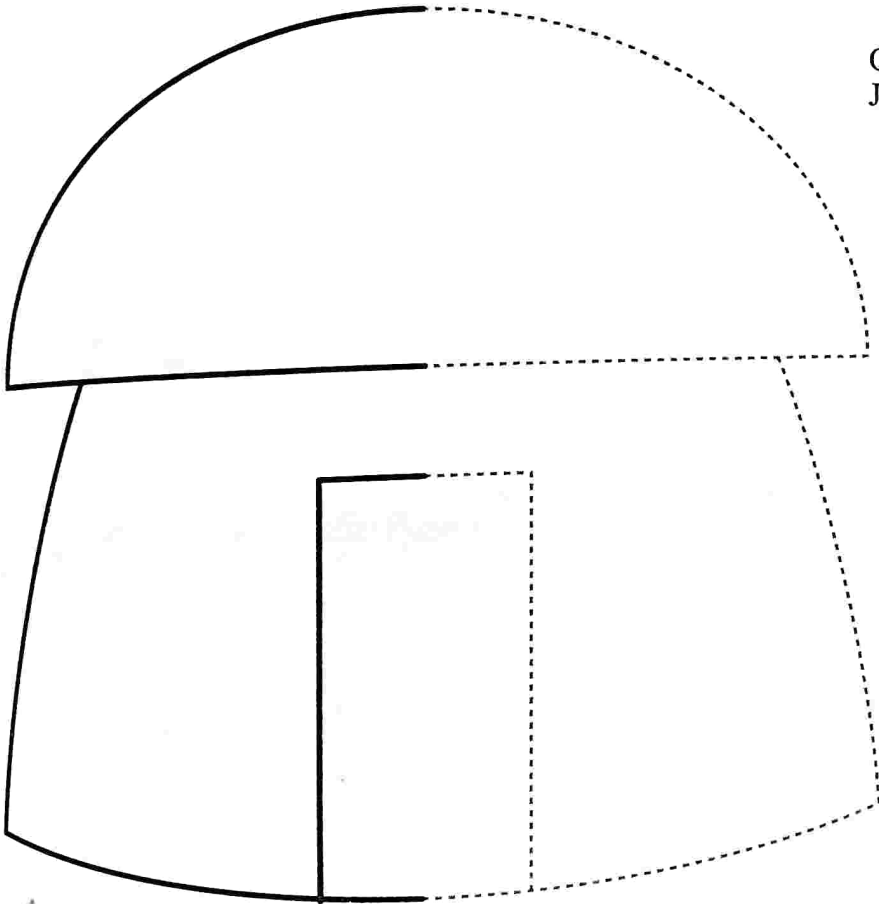

Date _____

Teacher's Signature _____

Rabbit

Observe the coloured model drawing.
Join the dots by black sketch pen and colour it.

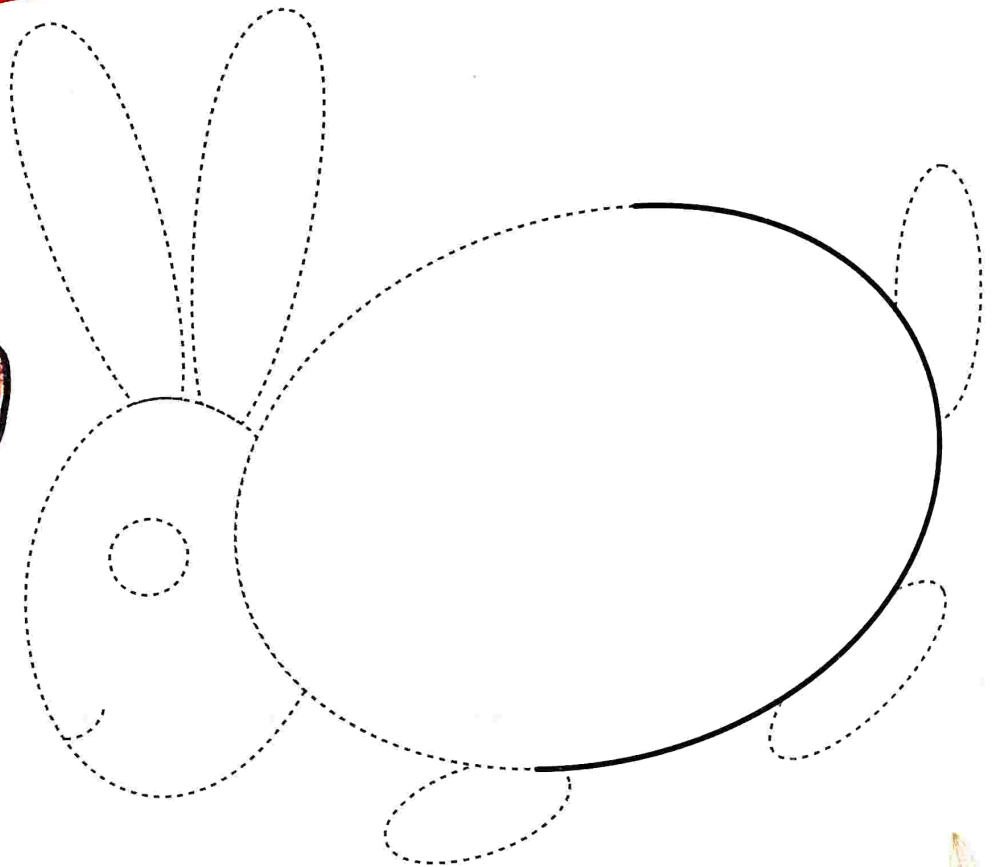
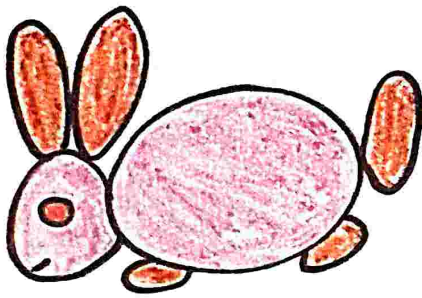

Date _____

Teacher's Signature _____

Tree



Observe the coloured model drawing.
Join the dots by black sketch pen and colour it.

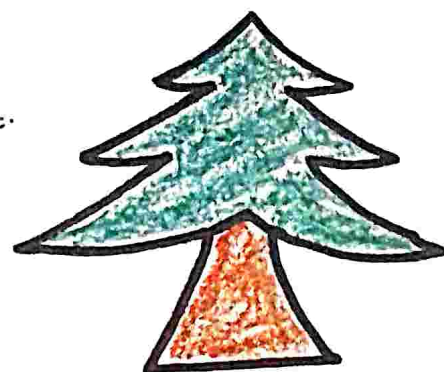
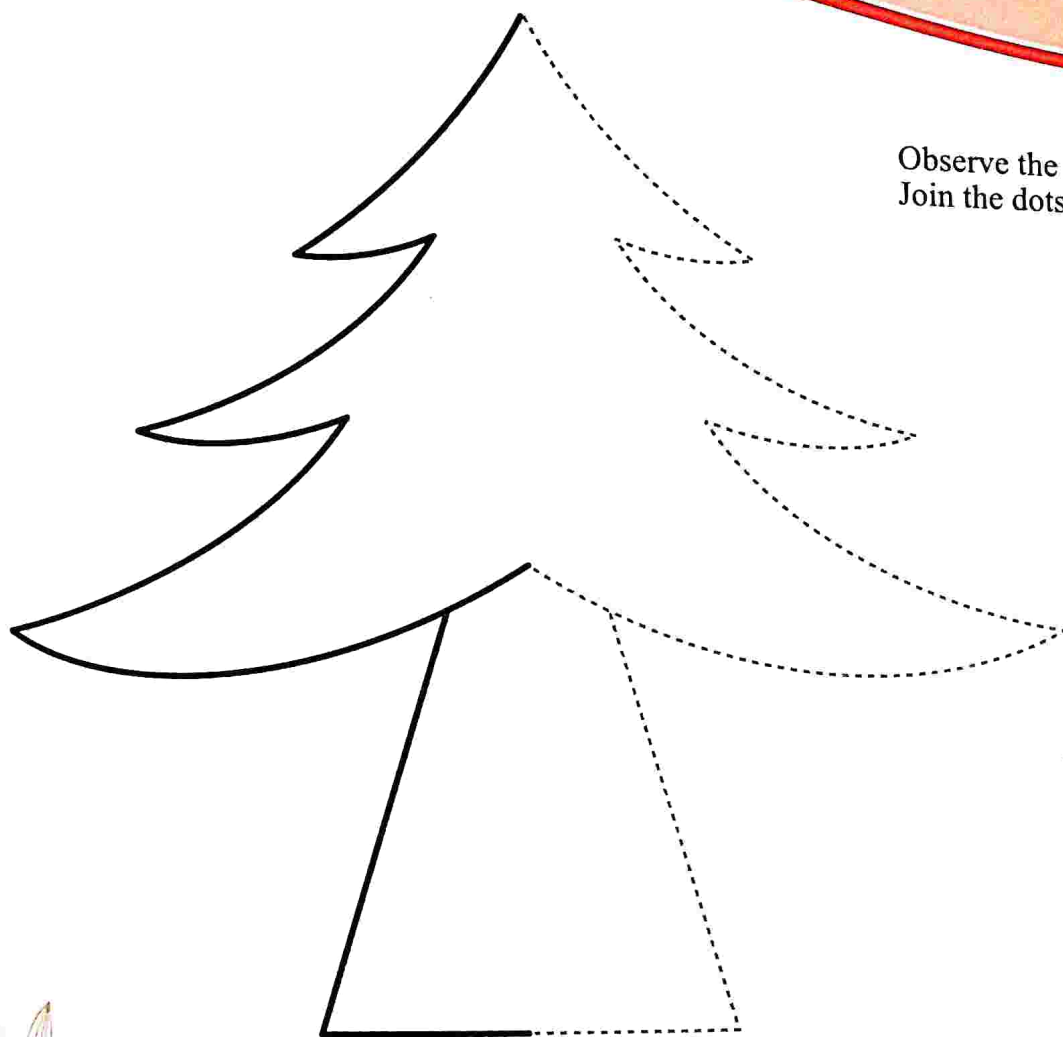

Date _____

Teacher's Signature _____



Turnip

Observe the coloured model drawing.
Join the dots by black sketch pen and colour it.

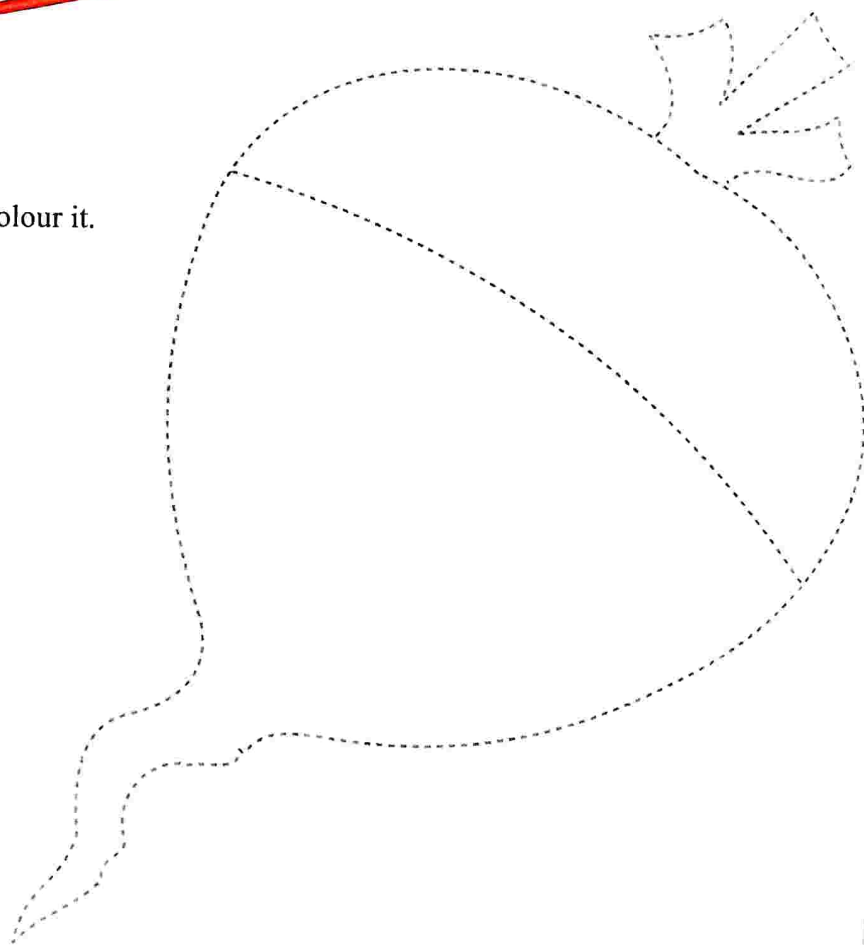
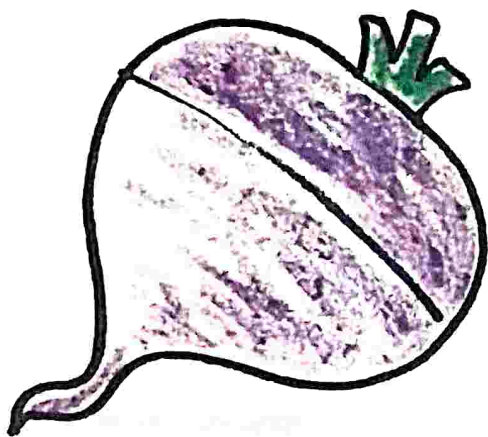

Date _____

Teacher's Signature _____





Vidya Prakashan Mandir (P) Ltd.
National Award Winner



ISBN 978-935066-252-6

